

### Applications

HBZ fans are designed for transporting clean air. It has many applications in industry, where in technological processes need a small airflow and high pressure. Typical applications:

- supplying air to gas burner systems,
- filtration systems,
- air transport,
- air drying systems,
- cooling systems.

### Construction

- high and very high-pressure, direct drive, radial fan,
- steel sheet rotor with backward inclined blades,
- steel welded housing,
- painted RAL 5010 (blue), corrosivity category C3,
- medium maximum temperature 80°C,
- ambient temperature of the motor from -30°C to +60°C (depending on model - see technical characteristic table),
- depending on the motor power, the fans are standard in two figures LG90 and LG270 (see specifications table),
- fans are standard in LG270 configuration.

### Electric motor

- asynchronous, three-phase 230V/400V 50Hz or 400/690V 50Hz, efficiency class IE3,
- degree of protection IP55,
- insulation class F,
- three-phase motors are adapted for frequency converter.

### Special executions

- optional configuration LG/RD,
- color other than standard and higher category of corrosivity,
- housing and support made of galvanized steel sheet, stainless steel 1.4301, acid-proof steel 1.4404,
- motor with voltage and frequency of power, degree of protection different than standard, equipped with sensors or additional cooling,
- sealing between the housing and the motor,
- HT version - maximum transported medium temperature higher than standard,
- ambient temperature range below -30°C and above +40°C,
- belt drive, clutch,
- ATEX version.

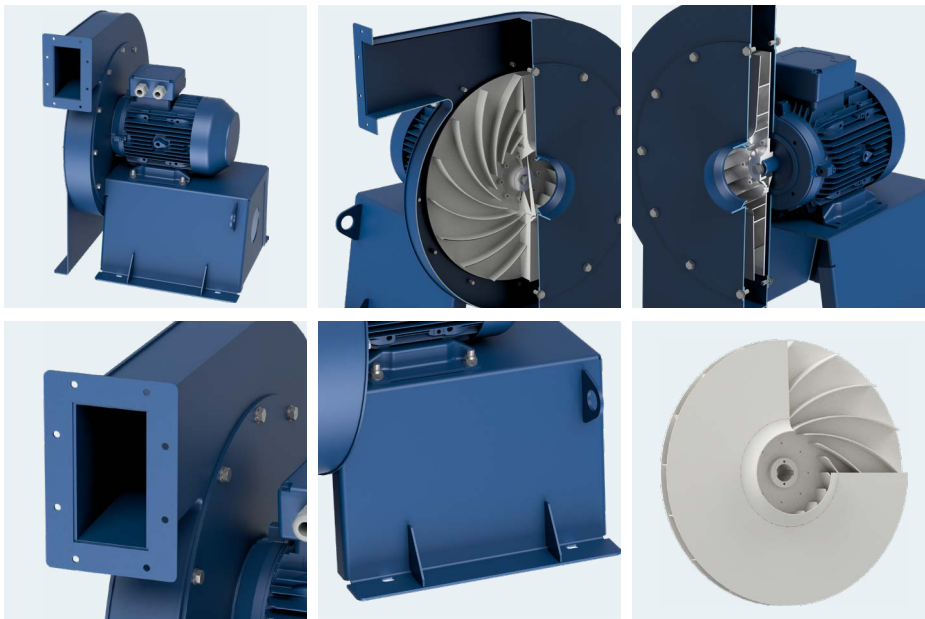

### RELATED PRODUCTS

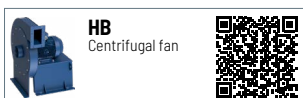



## NOMINAL DATA

type	airflow max	pressure max	speed	voltage rated	current max abs.**	power motor	sound pressure level*	temperature operating min / max	temperature ambient min / max	weight	article number
<b>THREE-PHASE 3000RPM</b>											
HBZ-2-40-075T	690 m <sup>3</sup> /h	3 080 Pa	2 890 rpm	3~400 V	1,7 A	0,75 kW	68 dB(A)	-30 / 80 °C	-30 / 60 °C	52,0 kg	436034020
HBZ-2-40-110T	1 140 m <sup>3</sup> /h	3 080 Pa	2 890 rpm	3~400 V	2,5 A	1,1 kW	68 dB(A)	-30 / 80 °C	-30 / 60 °C	53,0 kg	436034021
HBZ-2-40-150T	1 660 m <sup>3</sup> /h	3 080 Pa	2 880 rpm	3~400 V	3,0 A	1,5 kW	64 dB(A)	-30 / 80 °C	-30 / 40 °C	58,0 kg	436034022
HBZ-2-45-150T	1 150 m <sup>3</sup> /h	3 890 Pa	2 925 rpm	3~400 V	3,0 A	1,5 kW	72 dB(A)	-30 / 80 °C	-30 / 40 °C	65,0 kg	436034520
HBZ-2-45-220T	1 800 m <sup>3</sup> /h	3 890 Pa	2 910 rpm	3~400 V	4,3 A	2,2 kW	71 dB(A)	-30 / 80 °C	-30 / 40 °C	66,0 kg	436034521
HBZ-2-45-300T	2 690 m <sup>3</sup> /h	3 890 Pa	2 880 rpm	3~400 V	5,3 A	3,0 kW	69 dB(A)	-30 / 80 °C	-30 / 40 °C	73,0 kg	436034522
HBZ-2-50-220T	1 300 m <sup>3</sup> /h	4 800 Pa	2 910 rpm	3~400 V	4,3 A	2,2 kW	75 dB(A)	-30 / 80 °C	-30 / 40 °C	75,0 kg	436035020
HBZ-2-50-300T	1 900 m <sup>3</sup> /h	4 800 Pa	2 915 rpm	3~400 V	5,3 A	3,0 kW	75 dB(A)	-30 / 80 °C	-30 / 40 °C	81,0 kg	436035021
HBZ-2-50-400T	2 700 m <sup>3</sup> /h	4 800 Pa	2 895 rpm	3~400 V	7,3 A	4,0 kW	73 dB(A)	-30 / 80 °C	-30 / 40 °C	92,0 kg	436035022
HBZ-2-50-550T	3 700 m <sup>3</sup> /h	4 800 Pa	2 940 rpm	3~400 V	10 A	5,5 kW	71 dB(A)	-30 / 80 °C	-30 / 40 °C	111,0 kg	436035023
HBZ-2-56-400T	1 750 m <sup>3</sup> /h	6 030 Pa	2 895 rpm	3~400 V	7,3 A	4,0 kW	78 dB(A)	-30 / 80 °C	-30 / 40 °C	104,0 kg	436035620
HBZ-2-56-550T	2 850 m <sup>3</sup> /h	6 030 Pa	2 940 rpm	3~400 V	10 A	5,5 kW	79 dB(A)	-30 / 80 °C	-30 / 40 °C	123,0 kg	436035621
HBZ-2-56-750T	4 250 m <sup>3</sup> /h	6 030 Pa	2 930 rpm	3~400 V	13,3 A	7,5 kW	75 dB(A)	-30 / 80 °C	-30 / 40 °C	132,0 kg	436035622
HBZ-2-56-1100T	5 460 m <sup>3</sup> /h	6 030 Pa	2 925 rpm	3~400 V	19,3 A	11 kW	75 dB(A)	-30 / 80 °C	-30 / 40 °C	191,0 kg	436035623
HBZ-2-63-750T	2 800 m <sup>3</sup> /h	7 630 Pa	2 930 rpm	3~400 V	13,3 A	7,5 kW	81 dB(A)	-30 / 80 °C	-30 / 40 °C	153,0 kg	436036320
HBZ-2-63-1100T	4 500 m <sup>3</sup> /h	7 630 Pa	2 925 rpm	3~400 V	19,3 A	11 kW	80 dB(A)	-30 / 80 °C	-30 / 40 °C	212,0 kg	436036321
HBZ-2-63-1500T	6 600 m <sup>3</sup> /h	7 630 Pa	2 940 rpm	3~400 V	26 A	15 kW	76 dB(A)	-30 / 80 °C	-30 / 40 °C	221,0 kg	436036322
HBZ-2-63-1850T	7 350 m <sup>3</sup> /h	7 630 Pa	2 940 rpm	3~400 V	32,1 A	18,5 kW	77 dB(A)	-30 / 80 °C	-30 / 40 °C	228,0 kg	436036323
HBZ-2-71-1100T	3 000 m <sup>3</sup> /h	9 700 Pa	2 925 rpm	3~400 V	19,3 A	11 kW	85 dB(A)	-30 / 80 °C	-30 / 40 °C	233,0 kg	436037120
HBZ-2-71-1500T	4 900 m <sup>3</sup> /h	9 700 Pa	2 940 rpm	3~400 V	26 A	15 kW	86 dB(A)	-30 / 80 °C	-30 / 40 °C	244,0 kg	436037121
HBZ-2-71-1850T	6 000 m <sup>3</sup> /h	9 700 Pa	2 940 rpm	3~400 V	32,1 A	18,5 kW	86 dB(A)	-30 / 80 °C	-30 / 40 °C	251,0 kg	436037122
HBZ-2-71-2200T	7 300 m <sup>3</sup> /h	9 700 Pa	2 950 rpm	3~400 V	38,1 A	22 kW	84 dB(A)	-30 / 80 °C	-30 / 40 °C	302,0 kg	436037123
HBZ-2-71-3000T	10 380 m <sup>3</sup> /h	9 700 Pa	2 965 rpm	3~400 V	53 A	30 kW	81 dB(A)	-30 / 80 °C	-30 / 40 °C	370,0 kg	436037124
HBZ-2-80-2200T	5 100 m <sup>3</sup> /h	12 300 Pa	2 950 rpm	3~400 V	38,1 A	22 kW	89 dB(A)	-30 / 80 °C	-30 / 40 °C	327,0 kg	436038020
HBZ-2-80-3000T	7 500 m <sup>3</sup> /h	12 300 Pa	2 965 rpm	3~400 V	53 A	30 kW	90 dB(A)	-30 / 80 °C	-30 / 40 °C	395,0 kg	436038021
HBZ-2-80-3700T	9 000 m <sup>3</sup> /h	12 300 Pa	2 955 rpm	3~400 V	65 A	37 kW	89 dB(A)	-30 / 80 °C	-30 / 40 °C	410,0 kg	436038022
HBZ-2-80-4500T	12 400 m <sup>3</sup> /h	12 300 Pa	2 960 rpm	3~400 V	77 A	45 kW	85 dB(A)	-30 / 80 °C	-30 / 40 °C	525,0 kg	436038023
HBZ-2-80-5500T	14 800 m <sup>3</sup> /h	12 300 Pa	2 970 rpm	3~400 V	92 A	55 kW	84 dB(A)	-30 / 80 °C	-30 / 40 °C	560,0 kg	436038024
HBZ-2-90-3700T	5 800 m <sup>3</sup> /h	15 580 Pa	2 955 rpm	3~400 V	65 A	37 kW	93 dB(A)	-30 / 80 °C	-30 / 40 °C	454,0 kg	436039020
HBZ-2-90-4500T	8 100 m <sup>3</sup> /h	15 580 Pa	2 960 rpm	3~400 V	77 A	45 kW	93 dB(A)	-30 / 80 °C	-30 / 40 °C	576,0 kg	436039021
HBZ-2-90-5500T	10 800 m <sup>3</sup> /h	15 580 Pa	2 970 rpm	3~400 V	92 A	55 kW	92 dB(A)	-30 / 80 °C	-30 / 40 °C	611,0 kg	436039022
HBZ-2-90-7500T	16 100 m <sup>3</sup> /h	15 580 Pa	2 960 rpm	3~400 V	127 A	75 kW	88 dB(A)	-30 / 80 °C	-30 / 40 °C	761,0 kg	446039023
HBZ-2-90-9000T	20 350 m <sup>3</sup> /h	15 580 Pa	2 980 rpm	3~400 V	150 A	90 kW	90 dB(A)	-30 / 80 °C	-30 / 40 °C	851,0 kg	446039024
HBZ-2-100-7500T	11 300 m <sup>3</sup> /h	19 230 Pa	2 960 rpm	3~400 V	127 A	75 kW	96 dB(A)	-30 / 80 °C	-30 / 40 °C	789,0 kg	446031020
HBZ-2-100-9000T	14 000 m <sup>3</sup> /h	19 230 Pa	2 980 rpm	3~400 V	150 A	90 kW	95 dB(A)	-30 / 80 °C	-30 / 40 °C	879,0 kg	446031021
HBZ-2-100-11000T	18 000 m <sup>3</sup> /h	19 230 Pa	2 980 rpm	3~400 V	183 A	110 kW	93 dB(A)	-30 / 80 °C	-30 / 40 °C	1 023,0 kg	446031022
HBZ-2-100-13200T	21 500 m <sup>3</sup> /h	19 230 Pa	2 975 rpm	3~400 V	222 A	132 kW	91 dB(A)	-30 / 80 °C	-30 / 40 °C	1 196,0 kg	446031023
HBZ-2-100-16000T	26 600 m <sup>3</sup> /h	19 230 Pa	2 978 rpm	3~400 V	262 A	160 kW	93 dB(A)	-30 / 80 °C	-30 / 40 °C	1 344,0 kg	446031024
HBZ-2-100-20000T	29 100 m <sup>3</sup> /h	19 230 Pa	2 980 rpm	3~400 V	324 A	200 kW	94 dB(A)	-30 / 80 °C	-30 / 40 °C	1 411,0 kg	446031025

\*Measurement made at a distance of 1.5m from the outlet, for Q = 2/3 \* Qmax  
 \*\* value of the rated current may vary depending on the manufacturer of the electric motor used.



NOMINAL DATA

type	airflow max	pressure max	speed	voltage rated	current max abs.**	power motor	sound pressure level*	temperature operating min / max	temperature ambient min / max	weight	article number
<b>THREE-PHASE 1500RPM</b>											
HBZ-4-40-012T	495 m <sup>3</sup> /h	740 Pa	1380 rpm	3~400 V	0,45 A	0,12 kW	53 dB(A)	-30 / 80 °C	-30 / 60 °C	45,0 kg	436034040
HBZ-4-40-018T	815 m <sup>3</sup> /h	740 Pa	1380 rpm	3~400 V	0,65 A	0,18 kW	49 dB(A)	-30 / 80 °C	-30 / 60 °C	45,0 kg	436034041
HBZ-4-40-025T	925 m <sup>3</sup> /h	740 Pa	1380 rpm	3~400 V	0,85 A	0,25 kW	48 dB(A)	-30 / 80 °C	-15 / 60 °C	46,0 kg	436034042
HBZ-4-45-018T	600 m <sup>3</sup> /h	940 Pa	1380 rpm	3~400 V	0,65 A	0,18 kW	57 dB(A)	-30 / 80 °C	-15 / 60 °C	52,0 kg	436034540
HBZ-4-45-025T	850 m <sup>3</sup> /h	940 Pa	1380 rpm	3~400 V	0,85 A	0,25 kW	55 dB(A)	-30 / 80 °C	-15 / 60 °C	53,0 kg	436034541
HBZ-4-45-037T	1320 m <sup>3</sup> /h	940 Pa	1370 rpm	3~400 V	1,15 A	0,37 kW	51 dB(A)	-30 / 80 °C	-30 / 60 °C	54,0 kg	436034542
HBZ-4-50-025T	620 m <sup>3</sup> /h	1160 Pa	1380 rpm	3~400 V	0,85 A	0,25 kW	60 dB(A)	-30 / 80 °C	-30 / 60 °C	61,0 kg	436035040
HBZ-4-50-037T	1040 m <sup>3</sup> /h	1160 Pa	1370 rpm	3~400 V	1,15 A	0,37 kW	58 dB(A)	-30 / 80 °C	-30 / 60 °C	62,0 kg	436035041
HBZ-4-50-055T	1600 m <sup>3</sup> /h	1160 Pa	1400 rpm	3~400 V	1,7 A	0,55 kW	54 dB(A)	-30 / 80 °C	-30 / 60 °C	63,0 kg	436035042
HBZ-4-50-075T	1815 m <sup>3</sup> /h	1160 Pa	1430 rpm	3~400 V	2,1 A	0,75 kW	55 dB(A)	-30 / 80 °C	-30 / 60 °C	67,0 kg	436035043
HBZ-4-56-055T	1100 m <sup>3</sup> /h	1450 Pa	1400 rpm	3~400 V	1,7 A	0,55 kW	64 dB(A)	-30 / 80 °C	-30 / 60 °C	75,0 kg	436035640
HBZ-4-56-075T	1680 m <sup>3</sup> /h	1450 Pa	1430 rpm	3~400 V	2,1 A	0,75 kW	62 dB(A)	-30 / 80 °C	-30 / 60 °C	79,0 kg	436035641
HBZ-4-56-110T	2450 m <sup>3</sup> /h	1450 Pa	1430 rpm	3~400 V	2,5 A	1,1 kW	58 dB(A)	-30 / 80 °C	-30 / 40 °C	86,0 kg	436035642
HBZ-4-56-150T	2680 m <sup>3</sup> /h	1450 Pa	1440 rpm	3~400 V	3,6 A	1,5 kW	60 dB(A)	-30 / 80 °C	-30 / 40 °C	96,0 kg	436035643
HBZ-4-63-075T	1150 m <sup>3</sup> /h	1840 Pa	1430 rpm	3~400 V	2,1 A	0,75 kW	67 dB(A)	-30 / 80 °C	-30 / 60 °C	100,0 kg	436036340
HBZ-4-63-110T	1830 m <sup>3</sup> /h	1840 Pa	1430 rpm	3~400 V	2,5 A	1,1 kW	67 dB(A)	-30 / 80 °C	-30 / 40 °C	107,0 kg	436036341
HBZ-4-63-150T	2700 m <sup>3</sup> /h	1840 Pa	1440 rpm	3~400 V	3,6 A	1,5 kW	64 dB(A)	-30 / 80 °C	-30 / 40 °C	117,0 kg	436036342
HBZ-4-63-220T	3610 m <sup>3</sup> /h	1840 Pa	1465 rpm	3~400 V	4,6 A	2,2 kW	63 dB(A)	-30 / 80 °C	-30 / 40 °C	117,0 kg	436036343
HBZ-4-71-150T	1800 m <sup>3</sup> /h	2340 Pa	1440 rpm	3~400 V	3,6 A	1,5 kW	70 dB(A)	-30 / 80 °C	-30 / 40 °C	138,0 kg	436037140
HBZ-4-71-220T	3080 m <sup>3</sup> /h	2340 Pa	1465 rpm	3~400 V	4,6 A	2,2 kW	69 dB(A)	-30 / 80 °C	-30 / 40 °C	138,0 kg	436037141
HBZ-4-71-300T	4400 m <sup>3</sup> /h	2340 Pa	1460 rpm	3~400 V	6,7 A	3,0 kW	66 dB(A)	-30 / 80 °C	-30 / 40 °C	141,0 kg	436037142
HBZ-4-71-400T	5100 m <sup>3</sup> /h	2340 Pa	1460 rpm	3~400 V	8,1 A	4,0 kW	65 dB(A)	-30 / 80 °C	-30 / 40 °C	152,0 kg	436037143
HBZ-4-80-220T	1900 m <sup>3</sup> /h	2970 Pa	1465 rpm	3~400 V	4,6 A	2,2 kW	72 dB(A)	-30 / 80 °C	-30 / 40 °C	162,0 kg	436038040
HBZ-4-80-300T	2850 m <sup>3</sup> /h	2970 Pa	1460 rpm	3~400 V	6,7 A	3,0 kW	74 dB(A)	-30 / 80 °C	-30 / 40 °C	165,0 kg	436038041
HBZ-4-80-400T	4200 m <sup>3</sup> /h	2970 Pa	1460 rpm	3~400 V	8,1 A	4,0 kW	73 dB(A)	-30 / 80 °C	-30 / 40 °C	176,0 kg	436038042
HBZ-4-80-550T	5500 m <sup>3</sup> /h	2970 Pa	1460 rpm	3~400 V	10,9 A	5,5 kW	71 dB(A)	-30 / 80 °C	-30 / 40 °C	197,0 kg	436038043
HBZ-4-80-750T	7350 m <sup>3</sup> /h	2970 Pa	1465 rpm	3~400 V	14,4 A	7,5 kW	68 dB(A)	-30 / 80 °C	-30 / 40 °C	201,0 kg	436038044
HBZ-4-90-400T	2750 m <sup>3</sup> /h	3760 Pa	1460 rpm	3~400 V	8,1 A	4,0 kW	77 dB(A)	-30 / 80 °C	-30 / 40 °C	225,0 kg	436039040
HBZ-4-90-550T	4400 m <sup>3</sup> /h	3760 Pa	1460 rpm	3~400 V	10,9 A	5,5 kW	78 dB(A)	-30 / 80 °C	-30 / 40 °C	247,0 kg	436039041
HBZ-4-90-750T	6300 m <sup>3</sup> /h	3760 Pa	1465 rpm	3~400 V	14,4 A	7,5 kW	77 dB(A)	-30 / 80 °C	-30 / 40 °C	251,0 kg	436039042
HBZ-4-90-1100T	10100 m <sup>3</sup> /h	3760 Pa	1475 rpm	3~400 V	20,9 A	11 kW	74 dB(A)	-30 / 80 °C	-30 / 40 °C	320,0 kg	436039043
HBZ-4-100-750T	4500 m <sup>3</sup> /h	4650 Pa	1465 rpm	3~400 V	14,4 A	7,5 kW	80 dB(A)	-30 / 80 °C	-30 / 40 °C	279,0 kg	436031040
HBZ-4-100-1100T	7200 m <sup>3</sup> /h	4650 Pa	1475 rpm	3~400 V	20,9 A	11 kW	81 dB(A)	-30 / 80 °C	-30 / 40 °C	348,0 kg	436031041
HBZ-4-100-1500T	9600 m <sup>3</sup> /h	4650 Pa	1475 rpm	3~400 V	28,1 A	15 kW	80 dB(A)	-30 / 80 °C	-30 / 40 °C	366,0 kg	436031042
HBZ-4-100-1850T	12500 m <sup>3</sup> /h	4650 Pa	1475 rpm	3~400 V	33,9 A	18,5 kW	76 dB(A)	-30 / 80 °C	-30 / 40 °C	402,0 kg	436031043
HBZ-4-100-2200T	14400 m <sup>3</sup> /h	4650 Pa	1475 rpm	3~400 V	41,1 A	22 kW	75 dB(A)	-30 / 80 °C	-30 / 40 °C	412,0 kg	436031044

\*Measurement made at a distance of 1.5m from the outlet, for Q = 2/3 \* Qmax  
 \*\* value of the rated current may vary depending on the manufacturer of the electric motor used.



PERFORMANCE CHARACTERISTICS OF THE FANS - THREE-PHASE 3000RPM 40-56

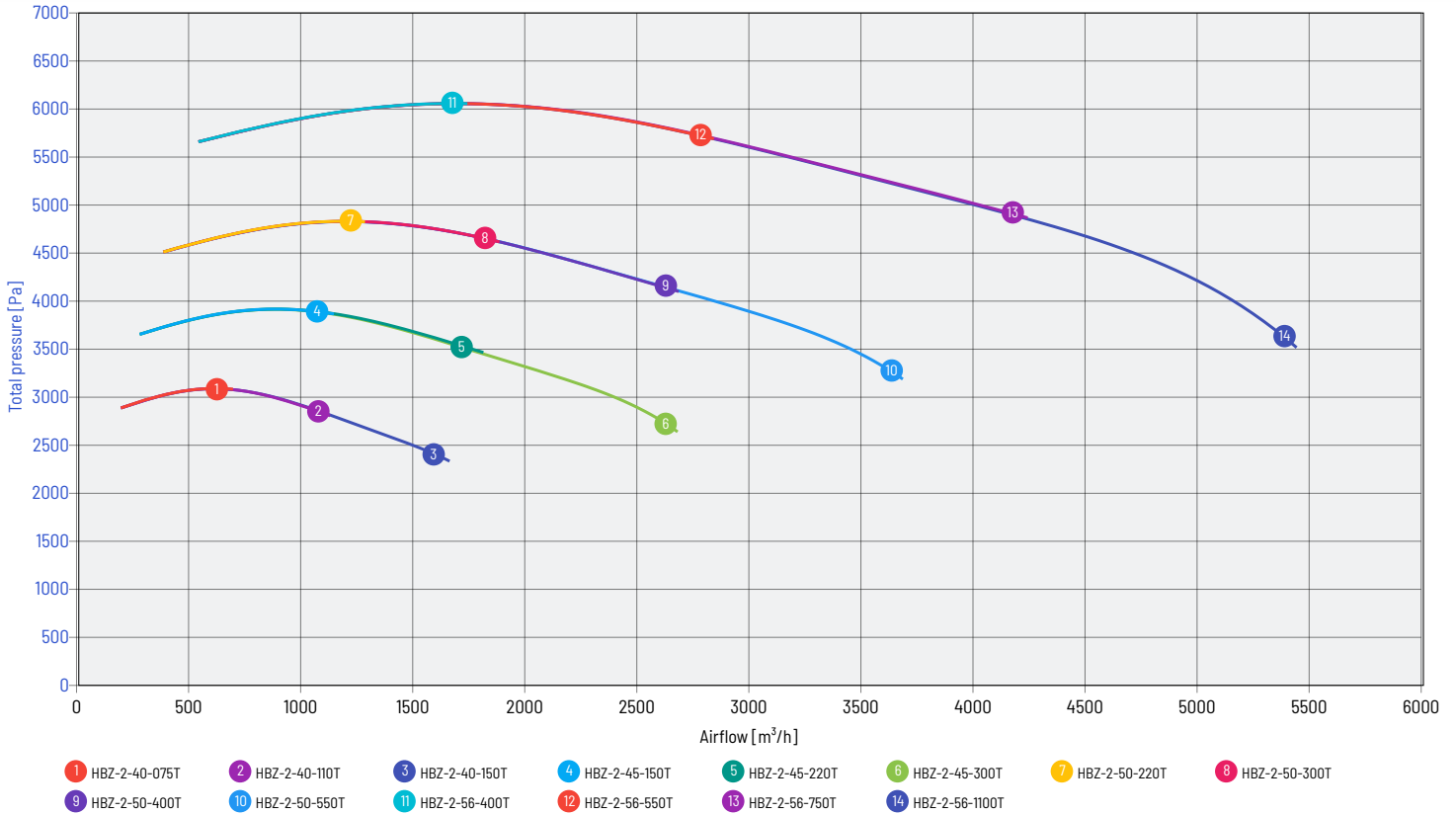

PERFORMANCE CHARACTERISTICS OF THE FANS - THREE-PHASE 3000RPM 63-100

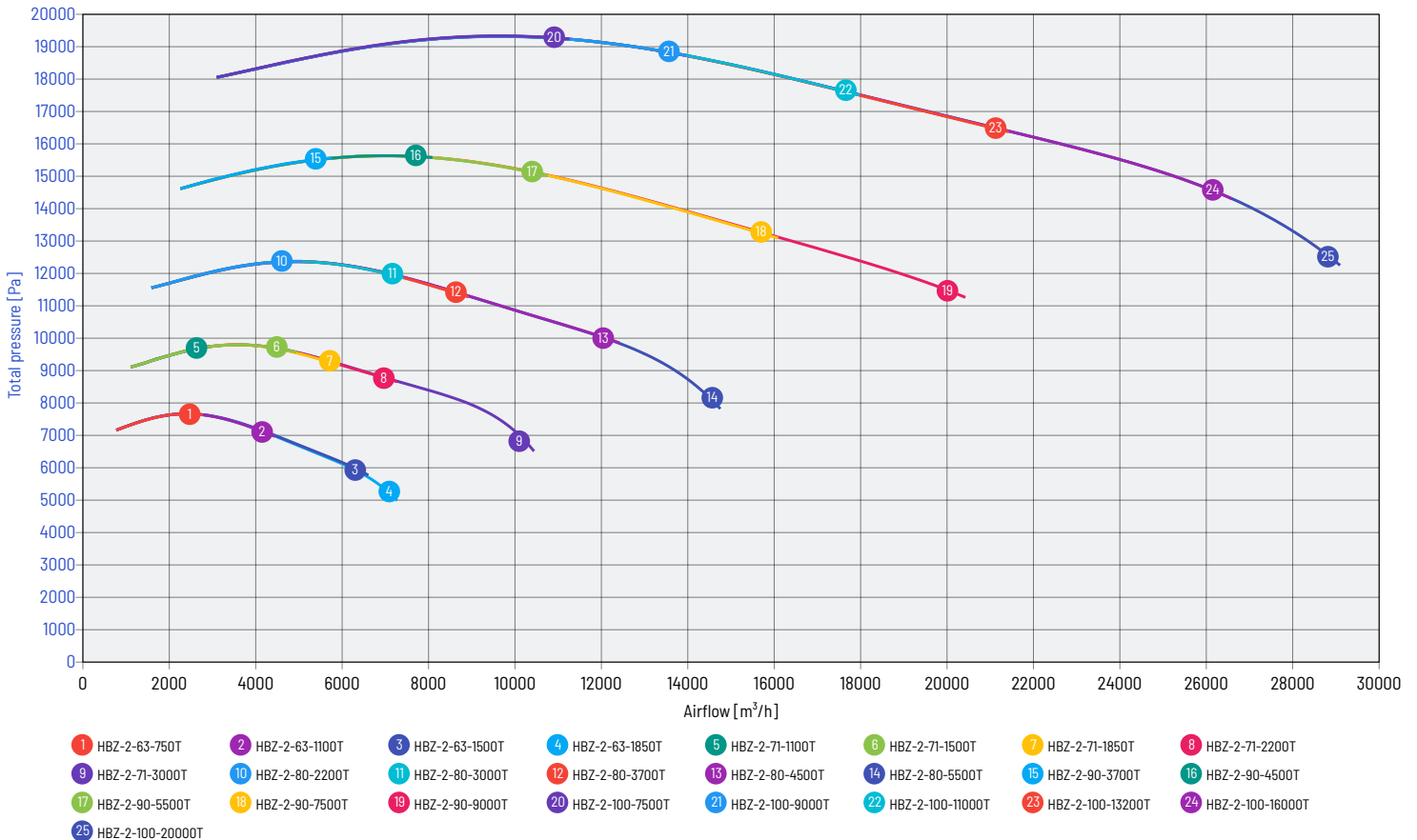



## PERFORMANCE CHARACTERISTICS OF THE FANS - THREE-PHASE 1500RPM 40-56

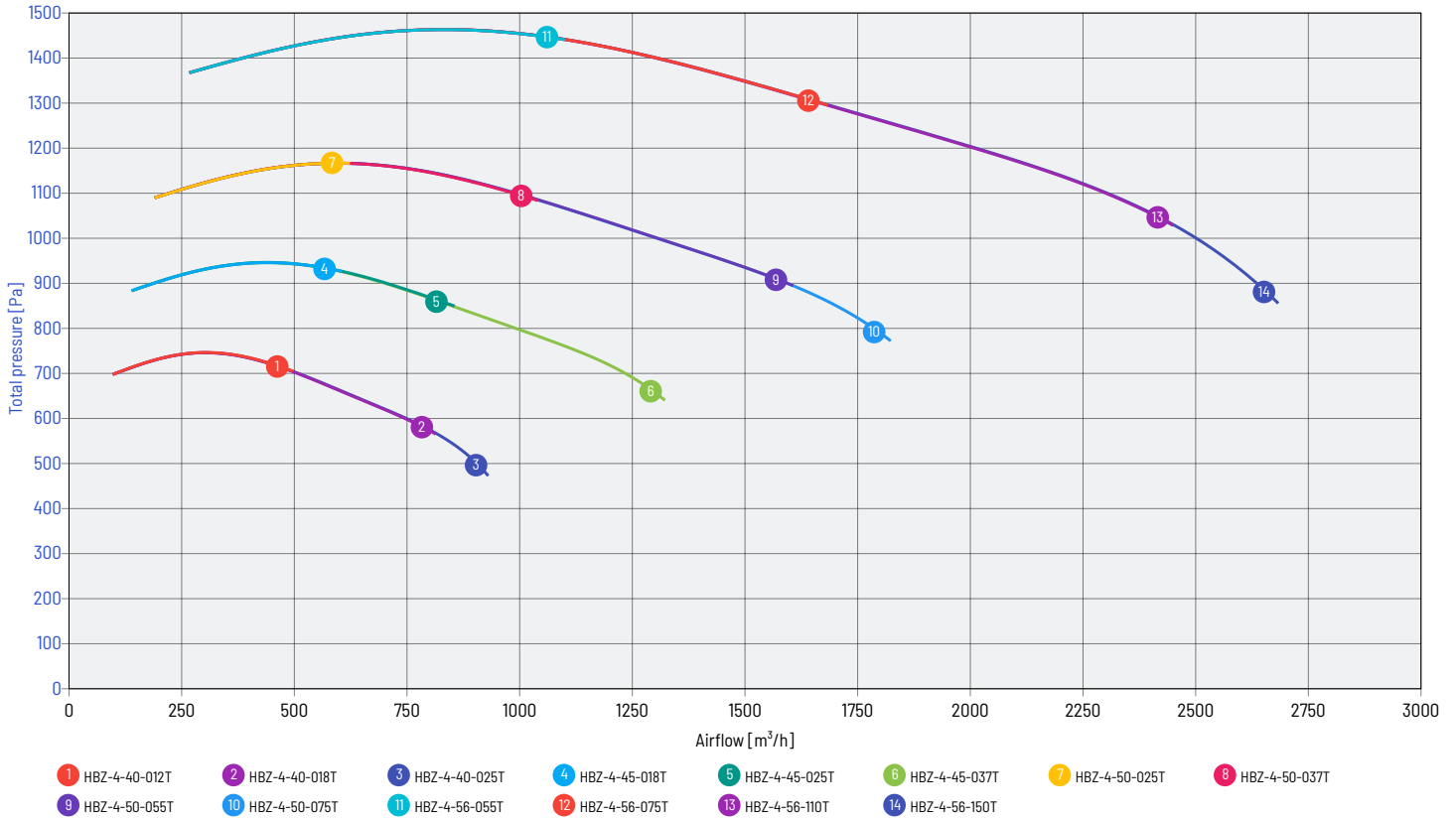

## PERFORMANCE CHARACTERISTICS OF THE FANS - THREE-PHASE 1500RPM 63-100

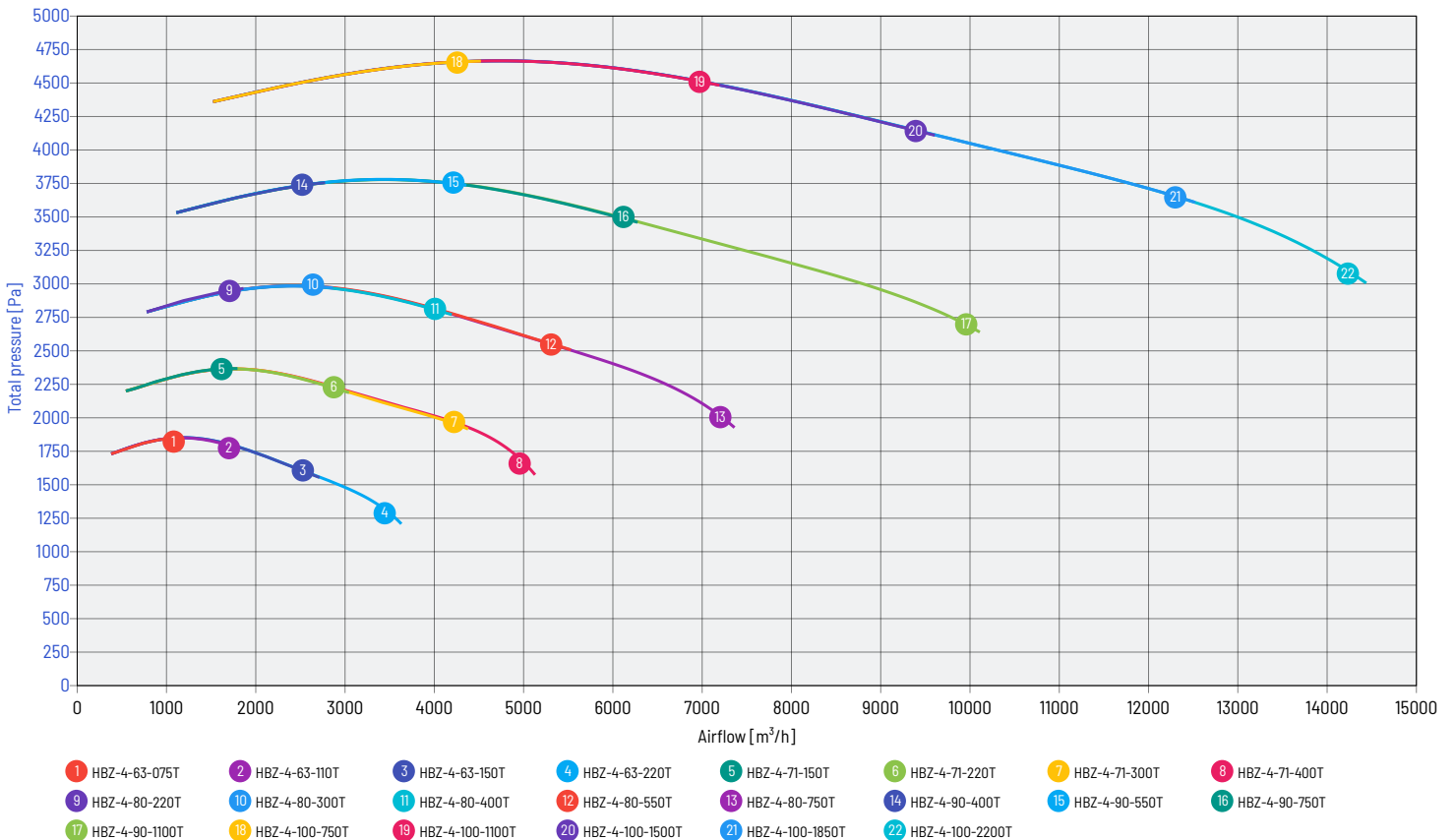



## PERFORMANCE CHARACTERISTICS OF THE FANS

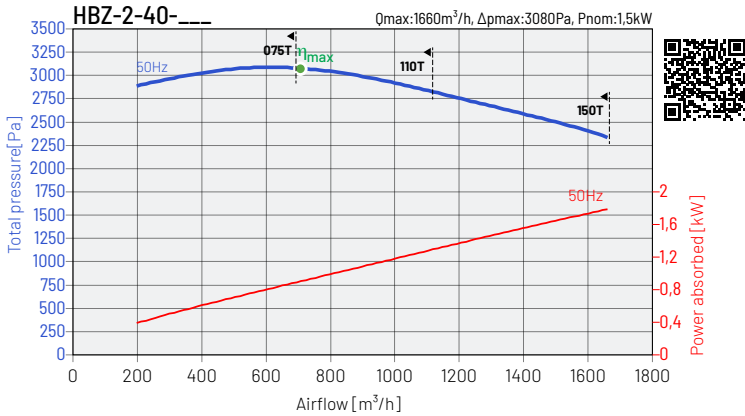

	MC	EC	SR	VSD	$\eta$ %	N	kW	m <sup>3</sup> /h	Pa	rpm
075T	C	static	1	no	59,1	65,6	0,92	701	2 825	2 890
110T	C	static	1	no	59,8	66,4	0,91	701	2 825	2 890
150T	C	static	1	no	60,8	67,3	0,90	699	2 805	2 880

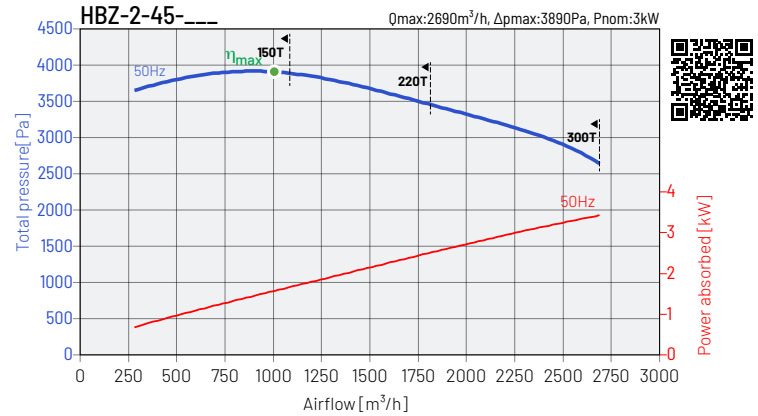

	MC	EC	SR	VSD	$\eta$ %	N	kW	m <sup>3</sup> /h	Pa	rpm
150T	C	static	1	no	60,6	65,6	1,62	1012	3 658	2 925
220T	C	static	1	no	61,8	66,9	1,59	1006	3 620	2 910
300T	C	static	1	no	62,7	67,8	1,56	996	3 546	2 880

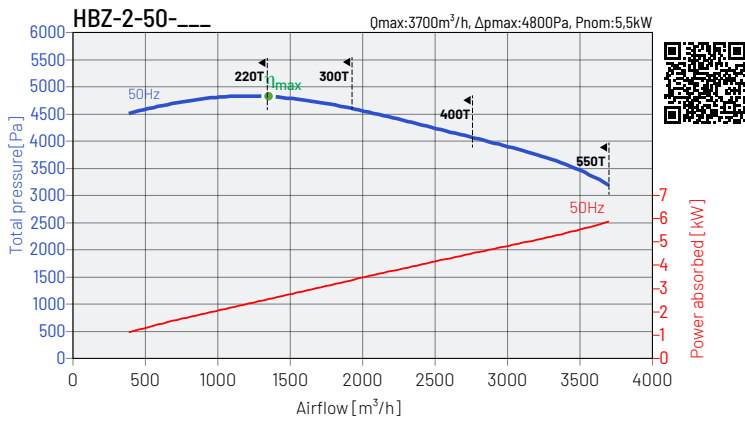

	MC	EC	SR	VSD	$\eta$ %	N	kW	m <sup>3</sup> /h	Pa	rpm
220T	C	static	1	no	61,9	65,5	2,69	1352	4 291	2 910
300T	C	static	1	no	62,7	66,4	2,65	1354	4 306	2 915
400T	C	static	1	no	63,4	67,1	2,62	1345	4 247	2 895
550T	C	static	1	no	64,2	68,0	2,59	1366	4 380	2 940

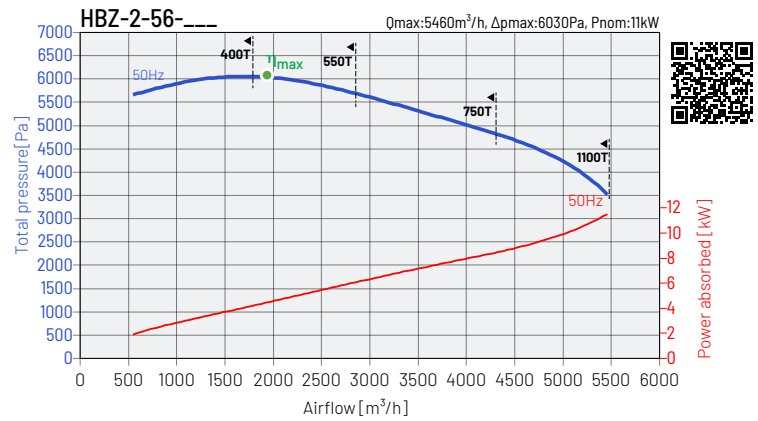

	MC	EC	SR	VSD	$\eta$ %	N	kW	m <sup>3</sup> /h	Pa	rpm
400T	C	static	1	no	64,7	66,9	4,62	1899	5 492	2 895
550T	C	static	1	no	65,5	67,7	4,56	1929	5 684	2 940
750T	C	static	1	no	66,3	68,5	4,51	1922	5 625	2 930
1100T	C	static	1	no	67,0	69,2	4,46	1919	5 606	2 925

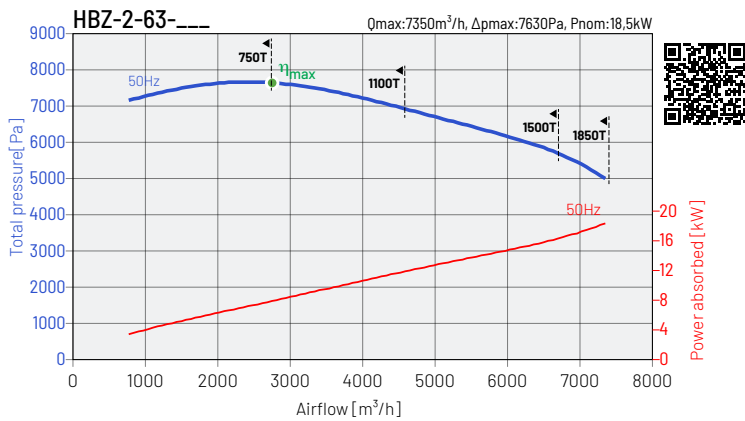

	MC	EC	SR	VSD	$\eta$ %	N	kW	m <sup>3</sup> /h	Pa	rpm
750T	C	static	1	no	64,8	65,4	8,13	2 723	7 583	2 930
1100T	C	static	1	no	65,6	66,3	8,04	2 718	7 557	2 925
1500T	C	static	1	no	66,1	66,8	7,97	2 732	7 635	2 940
1850T	C	static	1	no	66,5	67,2	7,93	2 732	7 635	2 940

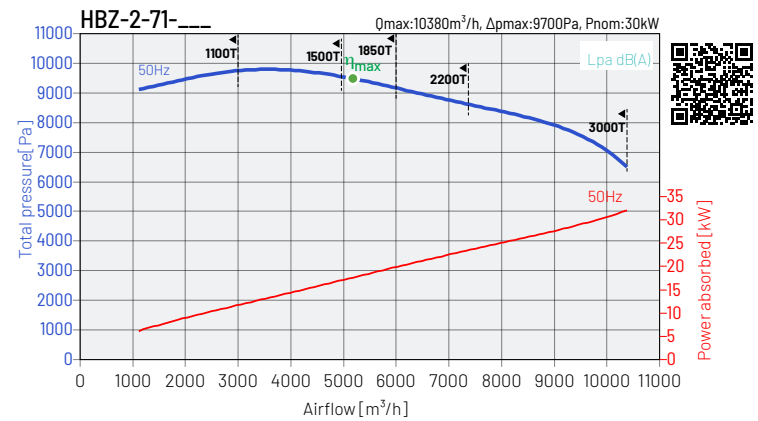

	MC	EC	SR	VSD	$\eta$ %	N	kW	m <sup>3</sup> /h	Pa	rpm
1100T	C	static	1	no	65,7	64,7	14,61	3 857	8 599	2 925
1500T	C	static	1	no	66,2	65,2	14,50	3 877	8 688	2 940
1850T	C	static	1	no	66,6	65,6	14,42	3 877	8 688	2 940
2200T	C	static	1	no	66,8	65,8	14,37	3 890	8 747	2 950
3000T	C	static	1	no	67,4	66,5	14,23	3 910	8 836	2 965

The performance characteristics of the fans are determined for a medium with a temperature of 20°C. Sound pressure level dB(A), determined at a distance of 1,5 m





## PERFORMANCE CHARACTERISTICS OF THE FANS

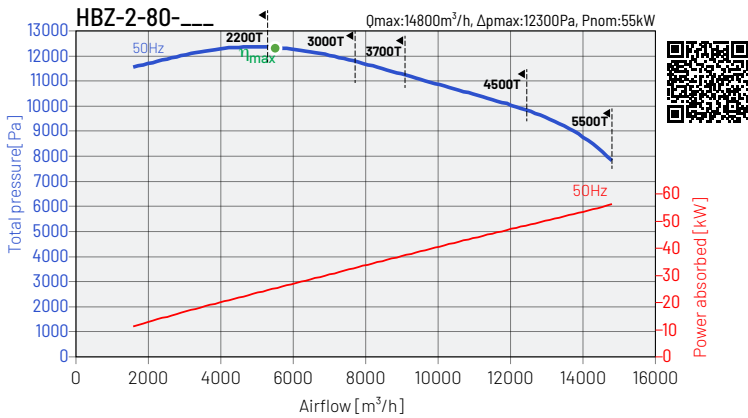

	MC	EC	SR	VSD	$\eta$ %	N	kW	m <sup>3</sup> /h	Pa	rpm
2200T	C	static	1	no	66,7	64,1	26,10	5 556	11 054	2 950
3000T	C	static	1	no	67,3	64,7	25,88	5 585	11 166	2 965
3700T	C	static	1	no	67,4	64,8	25,82	5 566	11 091	2 955
4500T	C	static	1	no	67,6	65,1	25,74	5 575	11 129	2 960
5500T	C	static	1	no	67,9	65,3	25,66	5 594	11 204	2 970

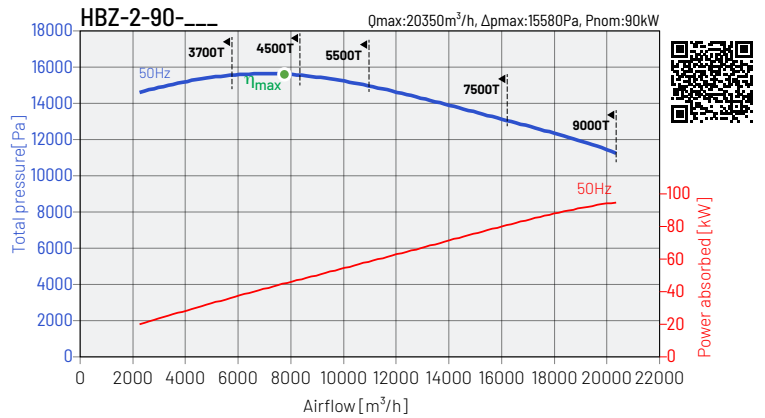

	MC	EC	SR	VSD	$\eta$ %	N	kW	m <sup>3</sup> /h	Pa	rpm
3700T	C	static	1	no	67,5	63,3	46,53	7 898	13 959	2 955
4500T	C	static	1	no	67,7	63,5	46,38	7 912	14 006	2 960
5500T	C	static	1	no	68,0	63,8	46,24	7 938	14 101	2 970
7500T	C	static	1	no	68,2	64,1	46,04	7 912	14 006	2 960
9000T	C	static	1	no	68,4	64,3	45,90	7 965	14 196	2 980

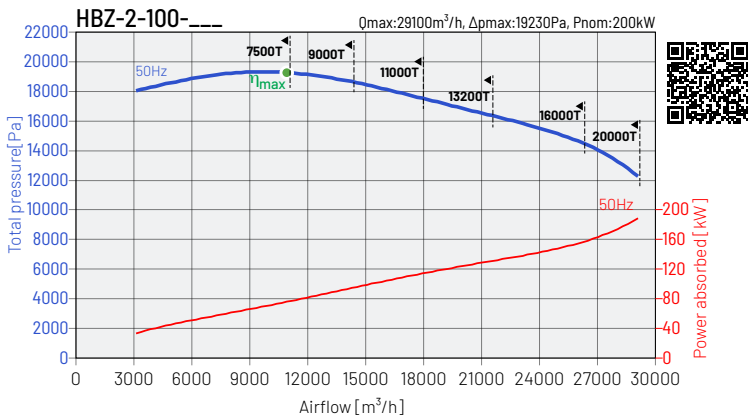

	MC	EC	SR	VSD	$\eta$ %	N	kW	m <sup>3</sup> /h	Pa	rpm
7500T	C	static	1	no	68,2	62,6	77,97	10 852	18 980	2 960
9000T	C	static	1	no	68,4	62,8	77,73	10 925	19 237	2 980
11000T	C	static	1	no	68,6	63,0	77,56	10 925	19 237	2 980
13200T	C	static	1	no	68,8	63,2	77,24	10 907	19 173	2 975
16000T	C	static	1	no	69,0	63,4	77,08	10 918	19 211	2 978
20000T	C	static	1	no	69,0	63,4	77,08	10 925	19 237	2 980

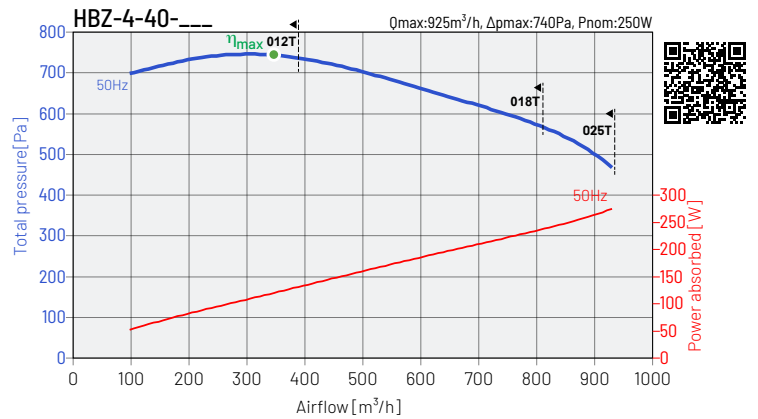

	MC	EC	SR	VSD	$\eta$ %	N	kW	m <sup>3</sup> /h	Pa	rpm
012T	C	static	1	no	51,9	63,9	0,13	344	678	1380
018T	C	static	1	no	52,6	64,7	0,13	344	678	1380
025T	C	static	1	no	54,0	66,2	0,13	344	678	1380

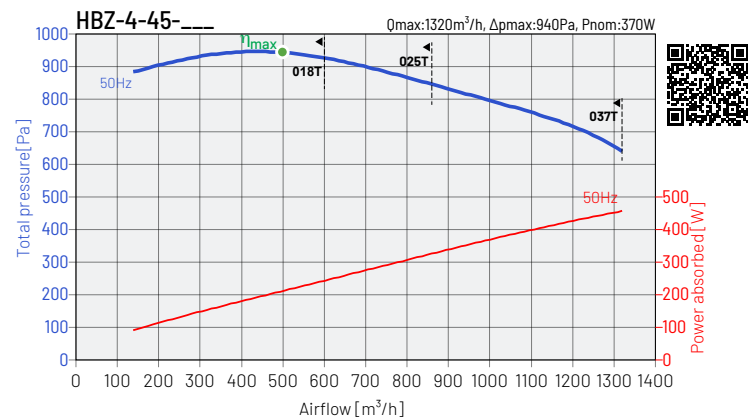

	MC	EC	SR	VSD	$\eta$ %	N	kW	m <sup>3</sup> /h	Pa	rpm
018T	C	static	1	no	52,5	63,0	0,22	493	870	1380
025T	C	static	1	no	54,0	64,5	0,22	493	870	1380
037T	C	static	1	no	55,6	66,3	0,21	489	857	1370

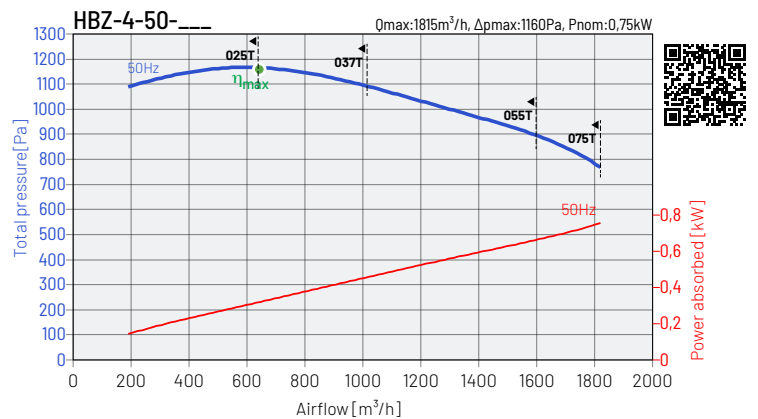

	MC	EC	SR	VSD	$\eta$ %	N	kW	m <sup>3</sup> /h	Pa	rpm
025T	C	static	1	no	54,0	63,1	0,37	648	985	1380
037T	C	static	1	no	55,7	64,8	0,35	643	971	1370
055T	C	static	1	no	58,7	68,0	0,34	657	1014	1400
075T	C	static	1	no	59,4	68,7	0,33	671	1058	1430

The performance characteristics of the fans are determined for a medium with a temperature of 20°C. Sound pressure level dB(A), determined at a distance of 1,5 m



## PERFORMANCE CHARACTERISTICS OF THE FANS

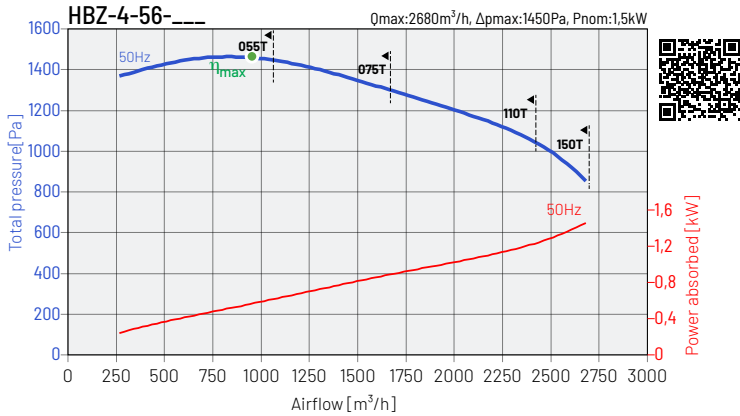

	MC	EC	SR	VSD	$\eta$ %	N	kW	m <sup>3</sup> /h	Pa	rpm
055T	C	static	1	no	59,9	67,6	0,59	917	1280	1400
075T	C	static	1	no	60,6	68,4	0,59	936	1335	1430
110T	C	static	1	no	61,8	69,6	0,57	936	1335	1430
150T	C	static	1	no	62,7	70,6	0,57	943	1354	1440

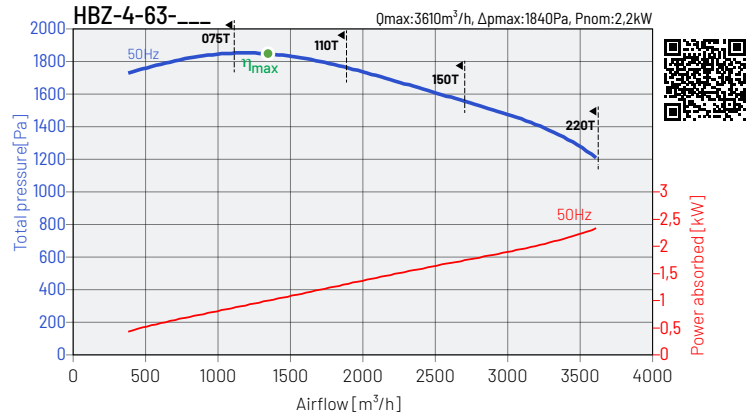

	MC	EC	SR	VSD	$\eta$ %	N	kW	m <sup>3</sup> /h	Pa	rpm
075T	C	static	1	no	59,4	65,5	1,06	1311	1600	1430
110T	C	static	1	no	60,5	66,8	1,04	1311	1600	1430
150T	C	static	1	no	61,4	67,7	1,02	1320	1622	1440
220T	C	static	1	no	62,4	68,7	1,00	1343	1679	1465

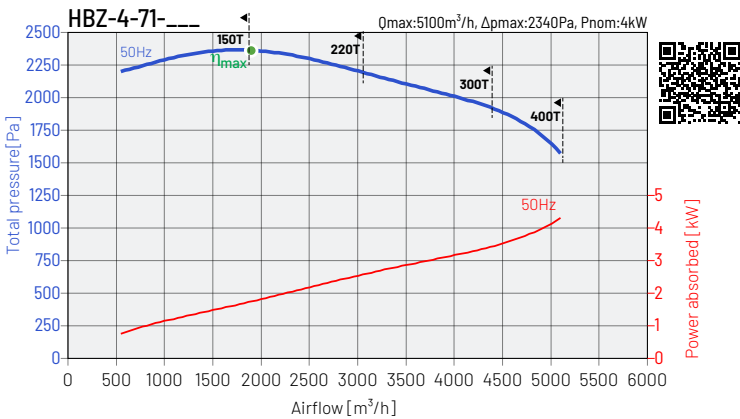

	MC	EC	SR	VSD	$\eta$ %	N	kW	m <sup>3</sup> /h	Pa	rpm
150T	C	static	1	no	61,5	66,1	1,86	1896	2 077	1440
220T	C	static	1	no	62,5	67,1	1,83	1929	2 150	1465
300T	C	static	1	no	63,2	67,9	1,80	1922	2 135	1460
400T	C	static	1	no	63,8	68,6	1,79	1922	2 135	1460

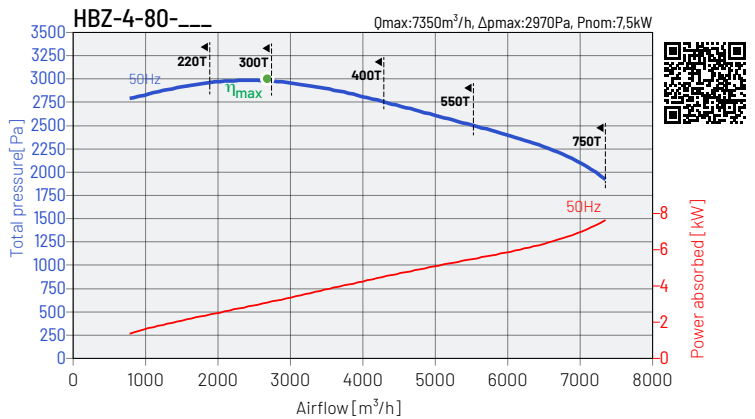

	MC	EC	SR	VSD	$\eta$ %	N	kW	m <sup>3</sup> /h	Pa	rpm
220T	C	static	1	no	62,4	65,4	3,31	2749	2 707	1465
300T	C	static	1	no	63,1	66,2	3,28	2 740	2 689	1460
400T	C	static	1	no	63,8	66,9	3,24	2 740	2 689	1460
550T	C	static	1	no	64,5	67,6	3,21	2 740	2 689	1460
750T	C	static	1	no	65,0	68,2	3,18	2 749	2 707	1465

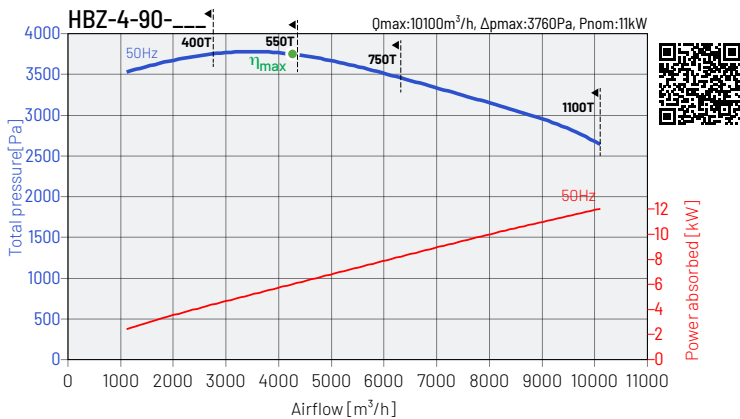

	MC	EC	SR	VSD	$\eta$ %	N	kW	m <sup>3</sup> /h	Pa	rpm
400T	C	static	1	no	63,8	65,3	5,84	3 875	3 361	1460
550T	C	static	1	no	64,5	66,1	5,78	3 875	3 361	1460
750T	C	static	1	no	65,1	66,7	5,73	3 888	3 384	1465
1100T	C	static	1	no	65,8	67,4	5,67	3 915	3 430	1475

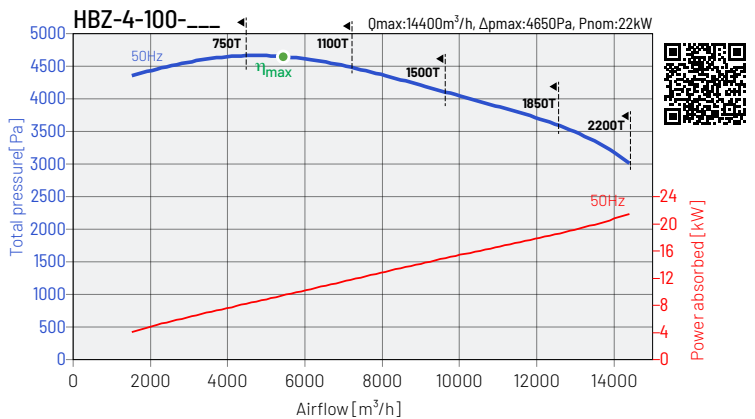

	MC	EC	SR	VSD	$\eta$ %	N	kW	m <sup>3</sup> /h	Pa	rpm
750T	C	static	1	no	65,1	65,2	9,70	5 334	4 176	1465
1100T	C	static	1	no	65,8	66,0	9,59	5 370	4 233	1475
1500T	C	static	1	no	66,3	66,5	9,52	5 370	4 233	1475
1850T	C	static	1	no	66,7	66,9	9,47	5 370	4 233	1475
2200T	C	static	1	no	67,0	67,2	9,44	5 370	4 233	1475

The performance characteristics of the fans are determined for a medium with a temperature of 20°C. Sound pressure level dB(A), determined at a distance of 1,5 m





DIMENSIONS

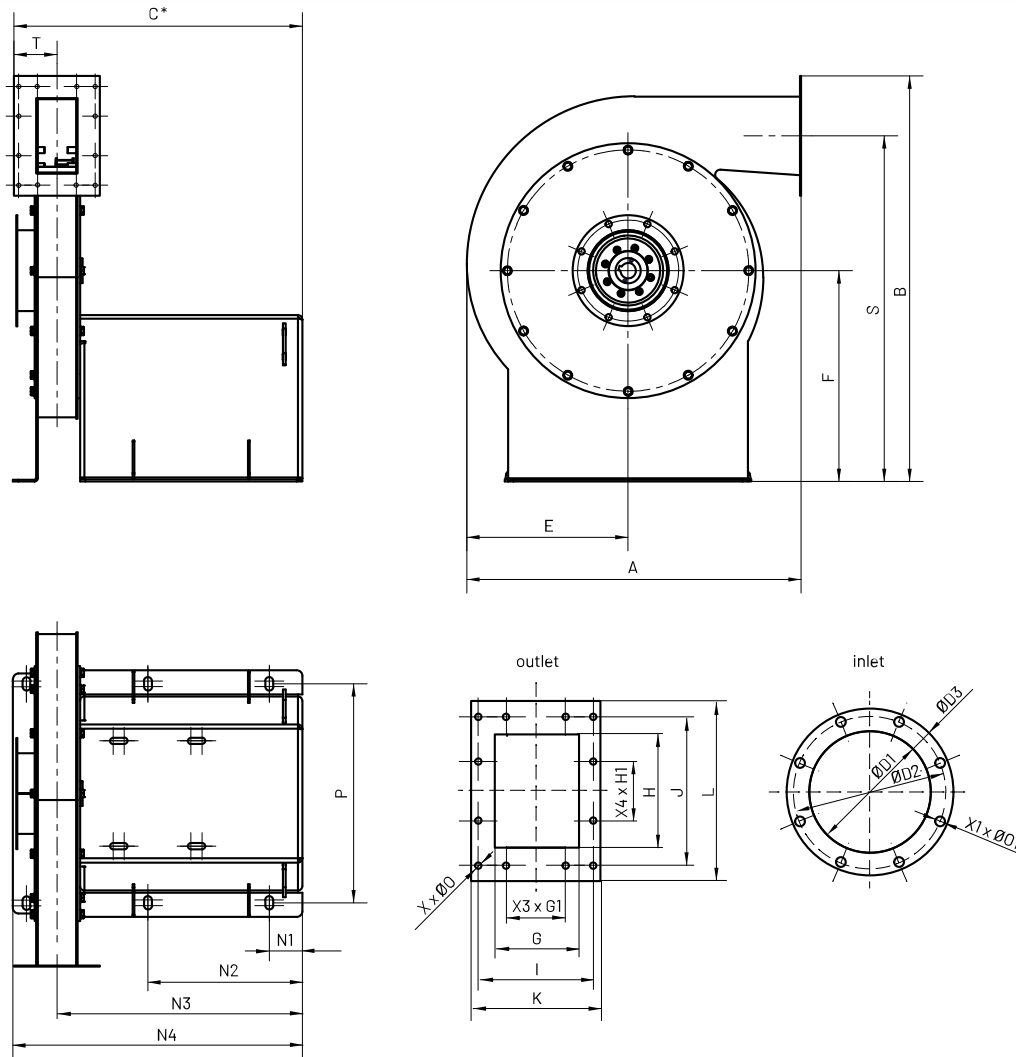

type	A	B	C*	ØD1	ØD2	ØD3	E	F*	G	H	I	J
	mm	mm	mm	mm	mm	mm	mm	mm	mm	mm	mm	mm
HBZ-x-40x	603	731	520	140	182	200	291	380	69	132	138	178
HBZ-x-45x	678	770	528	160	200	220	326	380	77	148	138	178
HBZ-x-50x	754	814	532	180	219	240	362	390	85	165	138	198
HBZ-x-56x	837	840	544	200	241	260	405	380	108	185	138	218
HBZ-x-63x	937	964	544	225	265	290	455	450	108	208	138	238
HBZ-x-71x	1114	1076	551	250	292	310	512	500	118	235	138	262
HBZ-x-80x	1209	1261	700	280	332	360	577	600	137	264	178	318
HBZ-x-90x	1340	1478	838	315	366	390	648	750	155	297	198	318
HBZ-x-100x	1483	1518	867	355	405	430	720	750	172	330	218	393

\* dimension for the longest motor version (depending on the motor manufacturer)

type	K	L	N1	N2	N3	N4	P	S	T	X1 x Ø01	X3 x G1	X4 x H1	X x Ø0
	mm	mm	mm	mm	mm	mm	mm	mm	mm	mm	mm	mm	mm
HBZ-x-40x	155	216	61	280	443	522	395	623	77,5	8x11,5	1x71	1x71	12x7
HBZ-x-45x	163	232	61	341	447	530	395	654	81,5	8x11,5	1x71	1x71	12x7
HBZ-x-50x	164	239	61	341	451	539	395	694	82	8x11,5	1x71	1x100	12x7
HBZ-x-56x	164	239	60	340	462	561	395	720	82	8x11,5	1x71	1x100	12x7
HBZ-x-63x	164	262	60	340	462	561	395	833	82	8x11,5	1x71	1x100	12x7
HBZ-x-71x	164	289	59	339	469	575	420	932	82	8x11,5	1x71	1x100	12x7
HBZ-x-80x	223	348	79	399	589	702	600	1087	111,5	8x11,5	1x71	1x125	12x10
HBZ-x-90x	221	361	106	526	681	834	740	1297	110,5	8x11,5	1x100	1x125	12x10
HBZ-x-100x	258	414	86	506	689	864	740	1309	129	8x11,5	1x100	2x125	14x10



## FIGURES

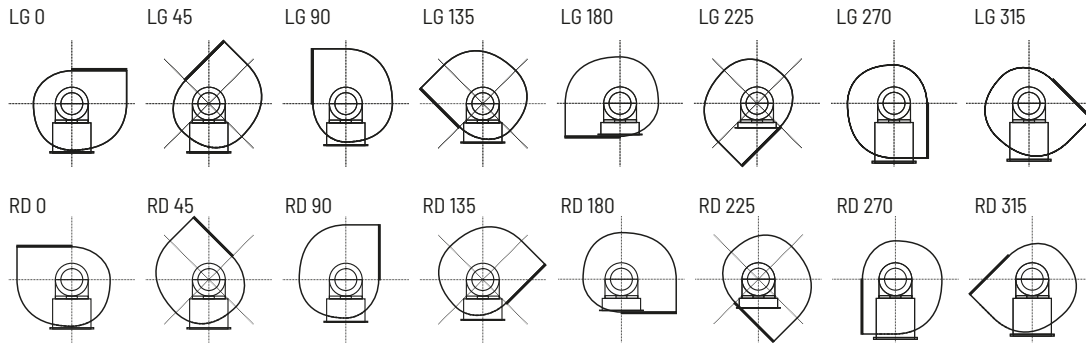

## ELECTRICAL ACCESSORIES



type	inverter L	service switch	type	inverter L	service switch	type	inverter L	service switch
HBZ-2-40-075T	L 0,75 kW	R-S 3-F + SP, 10A	HBZ-2-80-3700T	on request	on request	HBZ-4-56-075T	L 0,75 kW	R-S 3-F + SP, 10A
HBZ-2-40-110T	L 1,5 kW	R-S 3-F + SP, 10A	HBZ-2-80-4500T	on request	on request	HBZ-4-56-110T	L 1,5 kW	R-S 3-F + SP, 10A
HBZ-2-40-150T	L 1,5 kW	R-S 3-F + SP, 10A	HBZ-2-80-5500T	on request	on request	HBZ-4-56-150T	L 1,5 kW	R-S 3-F + SP, 10A
HBZ-2-45-150T	L 1,5 kW	R-S 3-F + SP, 10A	HBZ-2-90-3700T	on request	on request	HBZ-4-63-075T	L 0,75 kW	R-S 3-F + SP, 10A
HBZ-2-45-220T	L 2,2 kW	R-S 3-F + SP, 10A	HBZ-2-90-4500T	on request	on request	HBZ-4-63-110T	L 1,5 kW	R-S 3-F + SP, 10A
HBZ-2-45-300T	L 4,0 kW	R-S 3-F + SP, 10A	HBZ-2-90-5500T	on request	on request	HBZ-4-63-150T	L 1,5 kW	R-S 3-F + SP, 10A
HBZ-2-50-220T	L 2,2 kW	R-S 3-F + SP, 10A	HBZ-2-90-7500T	on request	on request	HBZ-4-63-220T	L 2,2 kW	R-S 3-F + SP, 10A
HBZ-2-50-300T	L 4,0 kW	R-S 3-F + SP, 10A	HBZ-2-90-9000T	on request	on request	HBZ-4-71-150T	L 1,5 kW	R-S 3-F + SP, 10A
HBZ-2-50-400T	L 4,0 kW	R-S 3-F + SP, 10A	HBZ-2-100-7500T	on request	on request	HBZ-4-71-220T	L 2,2 kW	R-S 3-F + SP, 10A
HBZ-2-50-550T	L 5,5 kW	R-S 3-F + SP, 16A	HBZ-2-100-9000T	on request	on request	HBZ-4-71-300T	L 4,0 kW	R-S 3-F + SP, 10A
HBZ-2-56-400T	L 4,0 kW	R-S 3-F + SP, 10A	HBZ-2-100-11000T	on request	on request	HBZ-4-71-400T	L 4,0 kW	R-S 3-F + SP, 10A
HBZ-2-56-550T	L 5,5 kW	R-S 3-F + SP, 16A	HBZ-2-100-13200T	on request	on request	HBZ-4-80-220T	L 2,2 kW	R-S 3-F + SP, 10A
HBZ-2-56-750T	L 7,5 kW	R-S 3-F + SP, 16A	HBZ-2-100-16000T	on request	on request	HBZ-4-80-300T	L 4,0 kW	R-S 3-F + SP, 10A
HBZ-2-56-1100T	L 11,0 kW	R-S 3-F + SP, 25A	HBZ-2-100-20000T	on request	on request	HBZ-4-80-400T	L 4,0 kW	R-S 3-F + SP, 10A
HBZ-2-63-750T	L 7,5 kW	R-S 3-F + SP, 16A	HBZ-4-40-012T	L 0,4 kW	R-S 3-F + SP, 10A	HBZ-4-80-550T	L 5,5 kW	R-S 3-F + SP, 16A
HBZ-2-63-1100T	L 11,0 kW	R-S 3-F + SP, 25A	HBZ-4-40-018T	L 0,4 kW	R-S 3-F + SP, 10A	HBZ-4-80-750T	L 7,5 kW	R-S 3-F + SP, 16A
HBZ-2-63-1500T	L 15,0 kW	R-S 3-F + SP, 40A	HBZ-4-40-025T	L 0,4 kW	R-S 3-F + SP, 10A	HBZ-4-90-400T	L 4,0 kW	R-S 3-F + SP, 10A
HBZ-2-63-1850T	L 18,5 kW	R-S 3-F + SP, 40A	HBZ-4-45-018T	L 0,4 kW	R-S 3-F + SP, 10A	HBZ-4-90-550T	L 5,5 kW	R-S 3-F + SP, 16A
HBZ-2-71-1100T	L 11,0 kW	R-S 3-F + SP, 25A	HBZ-4-45-025T	L 0,4 kW	R-S 3-F + SP, 10A	HBZ-4-90-750T	L 7,5 kW	R-S 3-F + SP, 16A
HBZ-2-71-1500T	L 15,0 kW	R-S 3-F + SP, 40A	HBZ-4-45-037T	L 0,4 kW	R-S 3-F + SP, 10A	HBZ-4-90-1100T	L 11,0 kW	R-S 3-F + SP, 25A
HBZ-2-71-1850T	L 18,5 kW	R-S 3-F + SP, 40A	HBZ-4-50-025T	L 0,4 kW	R-S 3-F + SP, 10A	HBZ-4-100-750T	L 7,5 kW	R-S 3-F + SP, 16A
HBZ-2-71-2200T	L 22,0 kW	R-S 3-F + SP, 40A	HBZ-4-50-037T	L 0,4 kW	R-S 3-F + SP, 10A	HBZ-4-100-1100T	L 11,0 kW	R-S 3-F + SP, 25A
HBZ-2-71-3000T	L 30,0 kW	R-S 3-F + SP, 63A	HBZ-4-50-055T	L 0,75 kW	R-S 3-F + SP, 10A	HBZ-4-100-1500T	L 15,0 kW	R-S 3-F + SP, 40A
HBZ-2-80-2200T	L 22,0 kW	R-S 3-F + SP, 40A	HBZ-4-50-075T	L 0,75 kW	R-S 3-F + SP, 10A	HBZ-4-100-1850T	L 18,5 kW	R-S 3-F + SP, 40A
HBZ-2-80-3000T	L 30,0 kW	R-S 3-F + SP, 63A	HBZ-4-56-055T	L 0,75 kW	R-S 3-F + SP, 10A	HBZ-4-100-2200T	L 22,0 kW	R-S 3-F + SP, 63A

### Article numbers

40016450 Inverter 0.4kW	40016456 Inverter 7.5kW	91040908-01 R-S 3-F + SP, 10A
40016451 Inverter 0.75kW	40016457 Inverter 11.0kW	91040908 R-S 3-F + SP, 16A
40016452 Inverter 1.5kW	40016458 Inverter 15.0kW	91040910 R-S 3-F + SP, 25A
40016453 Inverter 2.2kW	40016459 Inverter 18.5kW	91040924 R-S 3-F + SP, 40A
40016454 Inverter 4.0kW	40016460 Inverter 22.0kW	91040911-03 R-S 3-F + SP, 63A
40016455 Inverter 5.5kW	Inverter 30.0kW	