

# ROOF-V Wentylator dachowy



## Zastosowanie

Wentylatory dachowe wyciągowe ROOF-V przeznaczone są do wentylacji:

- magazynów, hal sklepowych i przemysłowych, budynków gospodarczych w rolnictwie, etc.

Ze względu na wysoką odporność temperaturową zalecane są zwłaszcza jako odciągi:

- z nad rusztów, z okapów w przemyśle mięsnym oraz gastronomii.

## Konstrukcja

- wirnik z łopatkami pochylonymi do tyłu, wykonane z blachy aluminiowej,
- podstawa i obudowa zewnętrzna wykonana z blachy aluminiowej,
- wsporniki i płyta nośna silnika wykonana z blachy nierdzewnej,
- osłona silnika wykonana z blachy aluminiowej,
- siatka ochronna z blachy nierdzewnej,
- przystosowany do pracy w pozycji pionowej,
- montaż na dachach płaskich,
- temperatura pracy od  $-20^{\circ}\text{C}$  do  $+120^{\circ}\text{C}$ .

## Silnik elektryczny

- asynchroniczny, jednofazowy, 230V, 50Hz (o mocy do 1,1 kW),
- asynchroniczny, trójfazowy, 230/400V, 50Hz (o mocy do 3 kW),
- asynchroniczny, trójfazowy, 400/690V, 50Hz (o mocy od 4 kW),
- stopień ochrony IP55,
- klasa izolacji F,
- przystosowany do regulacji napięciowej (silniki jednofazowe),
- przystosowany do regulacji częstotliwościowej (silniki trójfazowe).

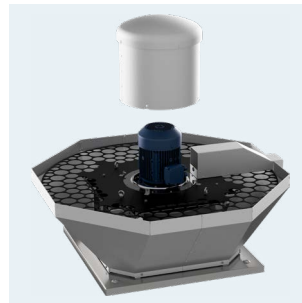
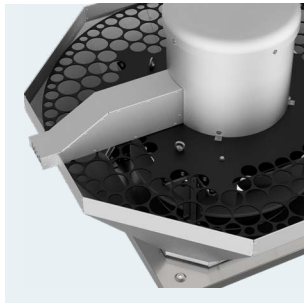

## POWIĄZANE PRODUKTY



**ROOF-H**  
Wentylator  
dachowy  
z wyrzutem  
poziomym



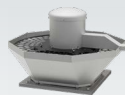

## DANE TECHNICZNE

model wentylatora	wydajność maksymalna	ciśnienie maksymalne	prędkość obrotowa	napięcie nominalne	natężenie znamionowe**	moc silnika	poziom ciśnienia akust.*	masa jednostki	numer artykułu
<b>SILNIKI CZTEROBIEGUNOWE JEDNOFAZOWE</b>									
ROOF-V/25/12/14S	1 150 m <sup>3</sup> /h	190 Pa	1 420 rpm	1~230 V	1,4 A	0,18 kW	52 dB(A)	19,0 kg	43534496
ROOF-V/28/16/14S	1 600 m <sup>3</sup> /h	240 Pa	1 430 rpm	1~230 V	2,5 A	0,25 kW	55 dB(A)	21,0 kg	43534501
ROOF-V/31/23/14S	2 300 m <sup>3</sup> /h	310 Pa	1 420 rpm	1~230 V	2,8 A	0,37 kW	58 dB(A)	27,0 kg	43534506
ROOF-V/35/33/14S	3 280 m <sup>3</sup> /h	395 Pa	1 430 rpm	1~230 V	3,8 A	0,55 kW	61 dB(A)	35,0 kg	43534511
ROOF-V/40/48/14S	4 780 m <sup>3</sup> /h	500 Pa	1 430 rpm	1~230 V	4,1 A	0,75 kW	63 dB(A)	41,0 kg	43534516
ROOF-V/45/68/14S	6 800 m <sup>3</sup> /h	630 Pa	1 300 rpm	1~230 V	7,5 A	1,1 kW	66 dB(A)	50,0 kg	43534521
<b>SILNIKI SZESCIOBIEGUNOWE JEDNOFAZOWE</b>									
ROOF-V/25/08/09S	760 m <sup>3</sup> /h	80 Pa	880 rpm	1~230 V	1,4 A	0,12 kW	51 dB(A)	20,0 kg	43534498
ROOF-V/28/11/09S	1 060 m <sup>3</sup> /h	110 Pa	880 rpm	1~230 V	1,4 A	0,12 kW	53 dB(A)	20,0 kg	43534503
ROOF-V/31/16/09S	1 570 m <sup>3</sup> /h	135 Pa	880 rpm	1~230 V	1,4 A	0,12 kW	56 dB(A)	25,0 kg	43534508
ROOF-V/35/21/09S	2 140 m <sup>3</sup> /h	175 Pa	920 rpm	1~230 V	1,6 A	0,18 kW	58 dB(A)	31,0 kg	43534513
ROOF-V/40/31/09S	3 080 m <sup>3</sup> /h	220 Pa	940 rpm	1~230 V	2,0 A	0,25 kW	61 dB(A)	37,0 kg	43534518
ROOF-V/45/46/09S	4 570 m <sup>3</sup> /h	275 Pa	930 rpm	1~230 V	2,9 A	0,37 kW	64 dB(A)	40,0 kg	43534523
ROOF-V/50/62/09S	6 180 m <sup>3</sup> /h	350 Pa	940 rpm	1~230 V	5,2 A	0,75 kW	67 dB(A)	60,0 kg	43534528
<b>SILNIKI CZTEROBIEGUNOWE TROJFAZOWE</b>									
ROOF-V/25/12/14T	1 150 m <sup>3</sup> /h	190 Pa	1 400 rpm	3~400 V	0,55 A	0,18 kW	52 dB(A)	19,0 kg	43534495
ROOF-V/28/16/14T	1 600 m <sup>3</sup> /h	240 Pa	1 410 rpm	3~400 V	0,8 A	0,25 kW	55 dB(A)	22,0 kg	43534500
ROOF-V/31/23/14T	2 300 m <sup>3</sup> /h	310 Pa	1 410 rpm	3~400 V	1,1 A	0,37 kW	58 dB(A)	27,0 kg	43534505
ROOF-V/35/33/14T	3 280 m <sup>3</sup> /h	395 Pa	1 420 rpm	3~400 V	1,6 A	0,55 kW	61 dB(A)	36,0 kg	43534510
ROOF-V/40/48/14T	4 780 m <sup>3</sup> /h	500 Pa	1 430 rpm	3~400 V	2,1 A	0,75 kW	63 dB(A)	41,0 kg	43534515
ROOF-V/45/68/14T	6 800 m <sup>3</sup> /h	630 Pa	1 430 rpm	3~400 V	2,5 A	1,1 kW	66 dB(A)	56,0 kg	43534520
ROOF-V/50/93/14T	9 300 m <sup>3</sup> /h	780 Pa	1 450 rpm	3~400 V	4,6 A	2,2 kW	69 dB(A)	80,0 kg	43534525
ROOF-V/56/130/14T	13 000 m <sup>3</sup> /h	970 Pa	1 460 rpm	3~400 V	6,7 A	3,0 kW	73 dB(A)	91,0 kg	43534530
<b>SILNIKI SZESCIOBIEGUNOWE TROJFAZOWE</b>									
ROOF-V/25/08/09T	760 m <sup>3</sup> /h	80 Pa	870 rpm	3~400 V	0,65 A	0,12 kW	51 dB(A)	21,0 kg	43534497
ROOF-V/28/11/09T	1 060 m <sup>3</sup> /h	110 Pa	870 rpm	3~400 V	0,65 A	0,12 kW	53 dB(A)	21,0 kg	43534502
ROOF-V/31/16/09T	1 570 m <sup>3</sup> /h	135 Pa	870 rpm	3~400 V	0,65 A	0,12 kW	56 dB(A)	26,0 kg	43534507
ROOF-V/35/21/09T	2 140 m <sup>3</sup> /h	175 Pa	900 rpm	3~400 V	0,7 A	0,18 kW	58 dB(A)	31,0 kg	43534512
ROOF-V/40/31/09T	3 080 m <sup>3</sup> /h	220 Pa	880 rpm	3~400 V	1,0 A	0,25 kW	61 dB(A)	36,0 kg	43534517
ROOF-V/45/46/09T	4 570 m <sup>3</sup> /h	275 Pa	880 rpm	3~400 V	1,3 A	0,37 kW	64 dB(A)	44,0 kg	43534522
ROOF-V/50/62/09T	6 180 m <sup>3</sup> /h	350 Pa	940 rpm	3~400 V	2,0 A	0,75 kW	67 dB(A)	62,0 kg	43534527
ROOF-V/56/88/09T	8 700 m <sup>3</sup> /h	440 Pa	940 rpm	3~400 V	2,8 A	1,1 kW	71 dB(A)	76,0 kg	43534532
ROOF-V/63/125/09T	12 490 m <sup>3</sup> /h	550 Pa	965 rpm	3~400 V	5,0 A	2,2 kW	72 dB(A)	118,0 kg	43534537
ROOF-V/71/178/09T	17 770 m <sup>3</sup> /h	705 Pa	965 rpm	3~400 V	6,2 A	3,0 kW	78 dB(A)	158,0 kg	43534542
ROOF-V/80/256/09T	25 600 m <sup>3</sup> /h	860 Pa	960 rpm	3~400 V	13,3 A	5,5 kW	82 dB(A)	188,0 kg	43534547
ROOF-V/90/364/09T	36 400 m <sup>3</sup> /h	1 090 Pa	970 rpm	3~400 V	21,4 A	11,0 kW	86 dB(A)	335,0 kg	43534552
ROOF-V/100/500/09T	50 000 m <sup>3</sup> /h	1 350 Pa	980 rpm	3~400 V	36,4 A	18,5 kW	89 dB(A)	500,0 kg	43534557

\*pomiar wykonany w odległości 1,5m od wylotu, dla  $\theta = 2/3^{\circ}\theta_{max}$

\*\* wartość prądu znamionowego może się różnić w zależności od producenta zastosowanego silnika elektrycznego.

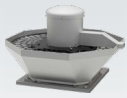

## CHARAKTERYSTYKI PRACY WENTYLATORÓW

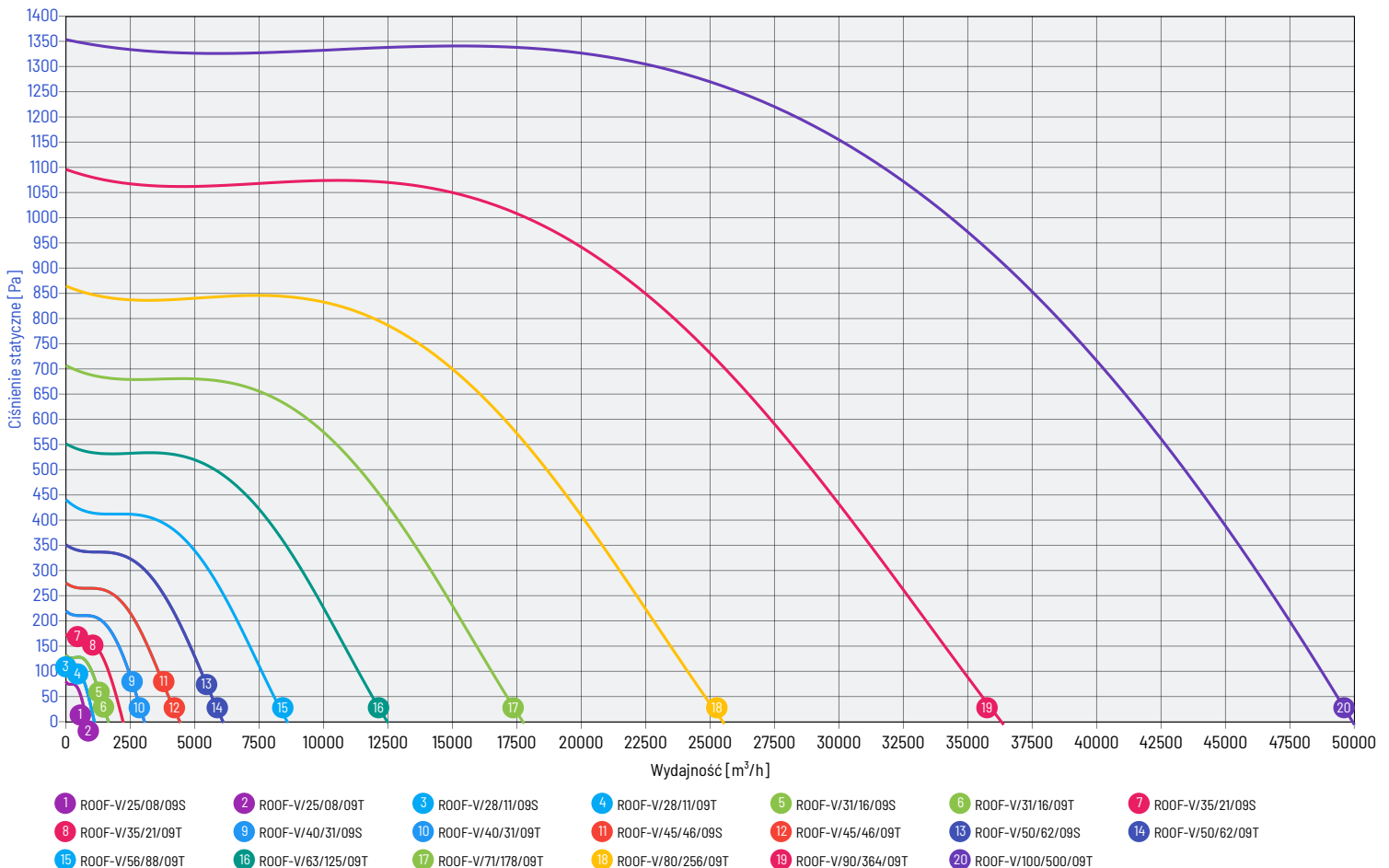
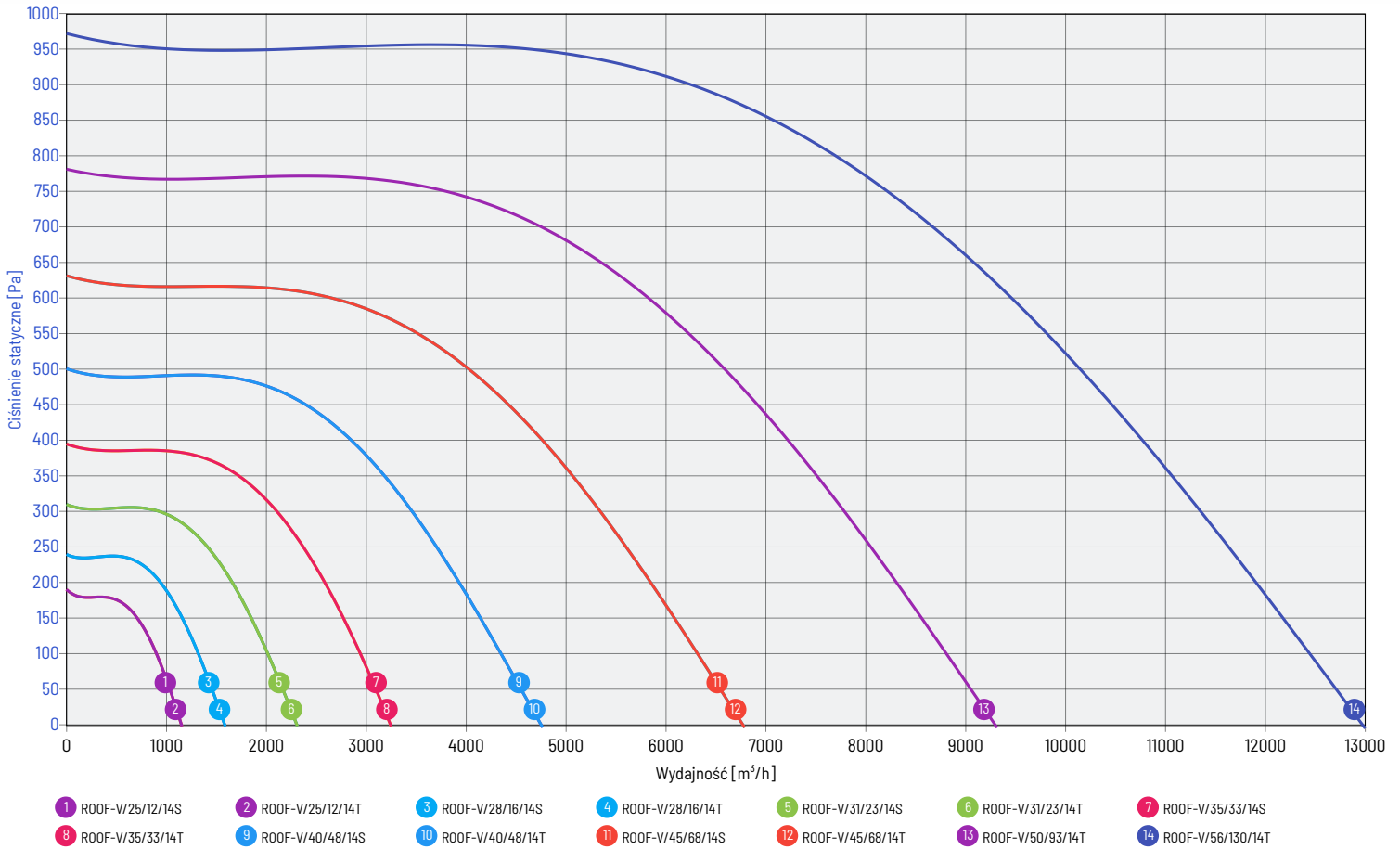



## CHARAKTERYSTYKI PRACY WENTYLATORÓW

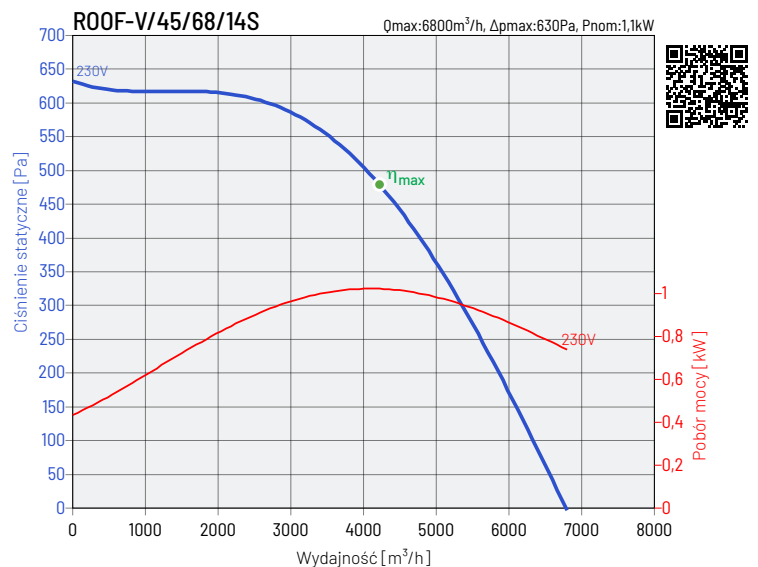
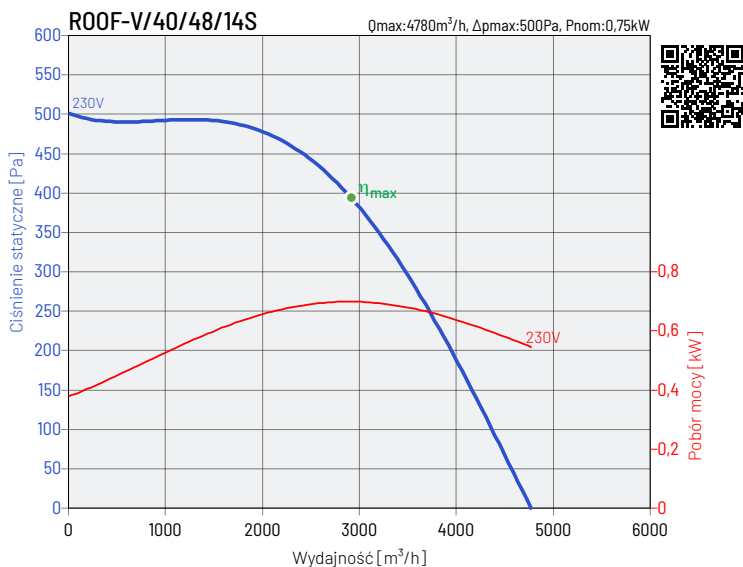
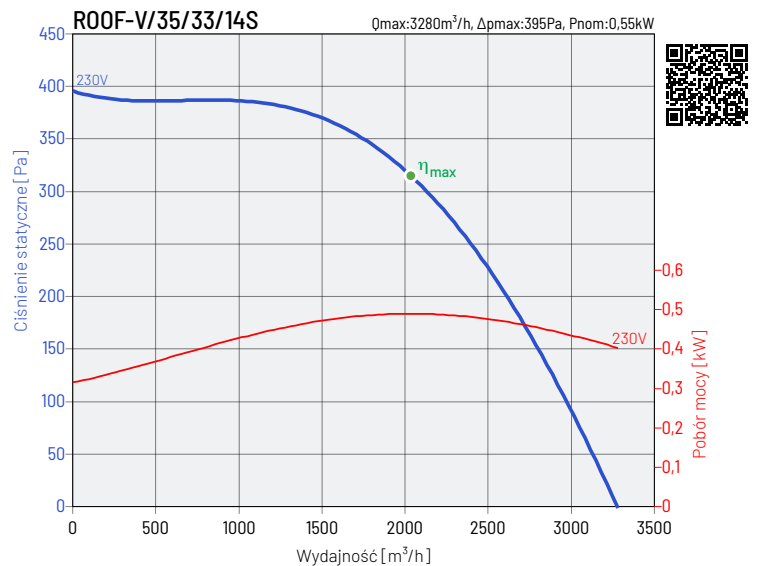
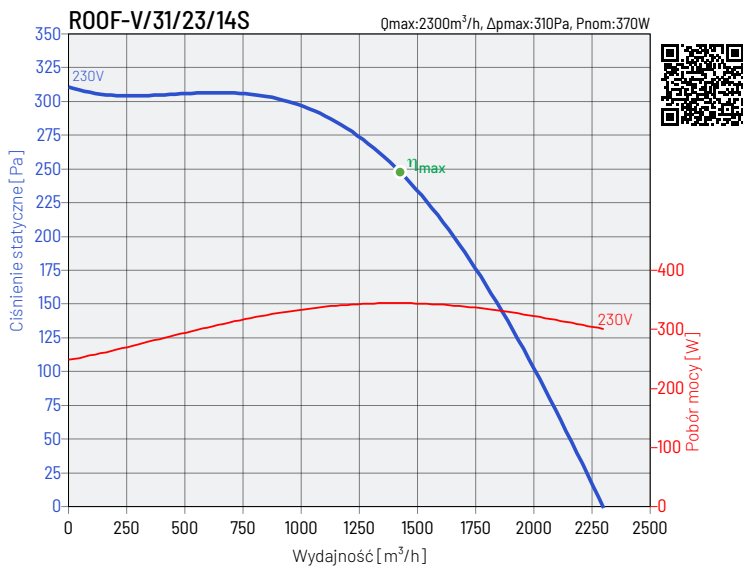
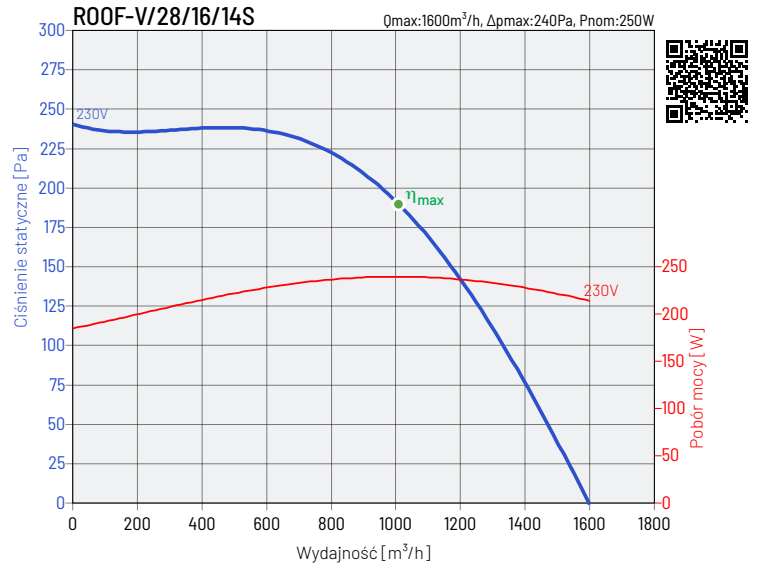
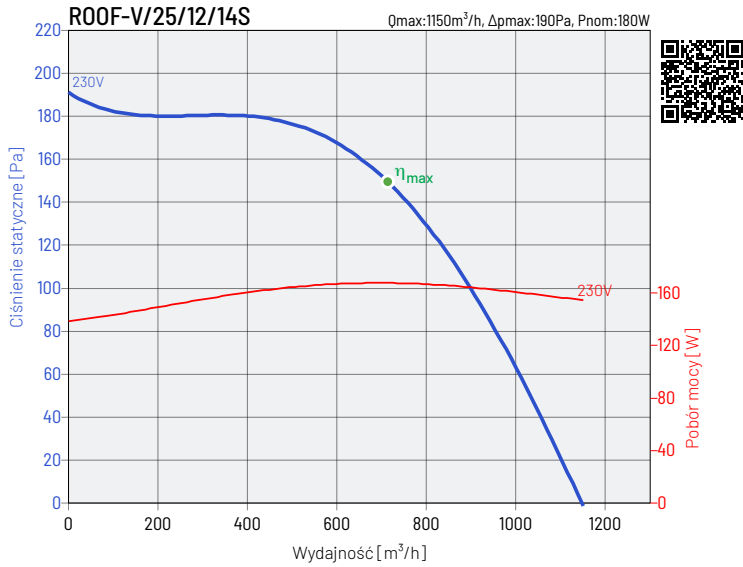

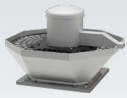

## CHARAKTERYSTYKI PRACY WENTYLATORÓW

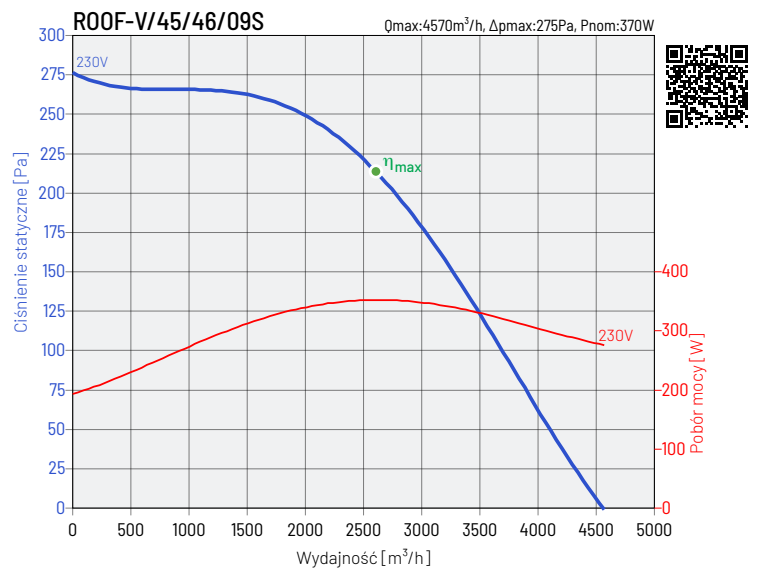
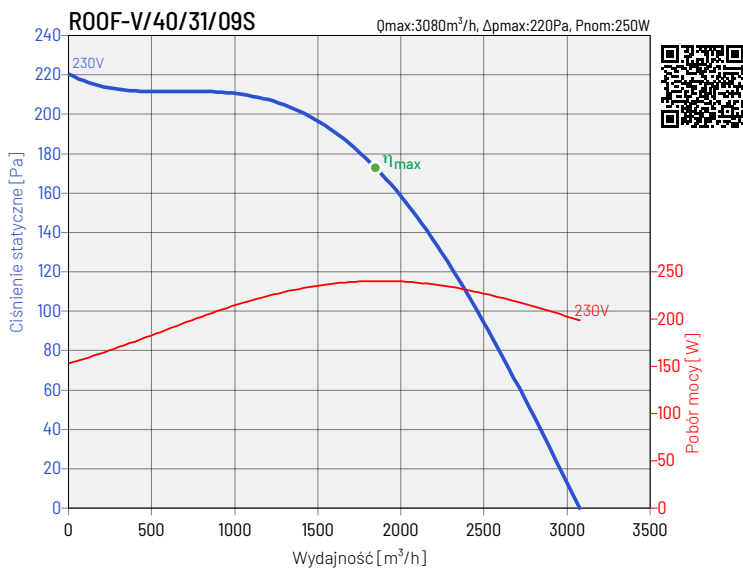
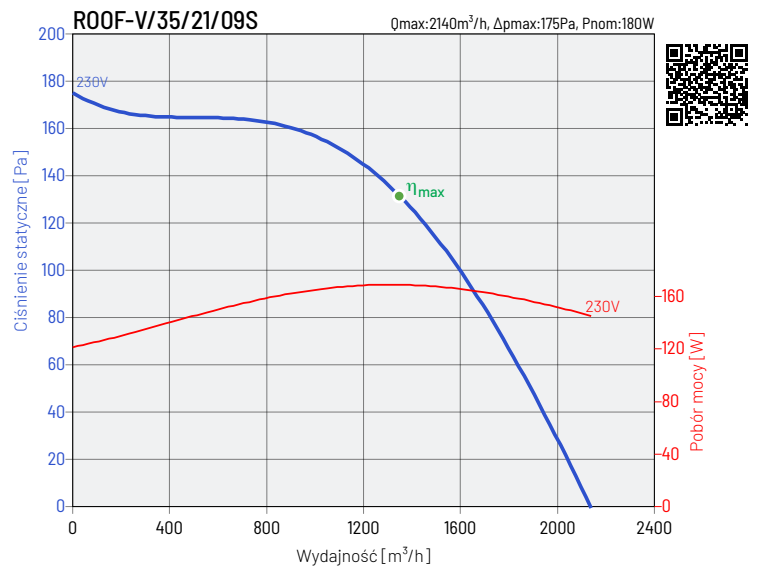
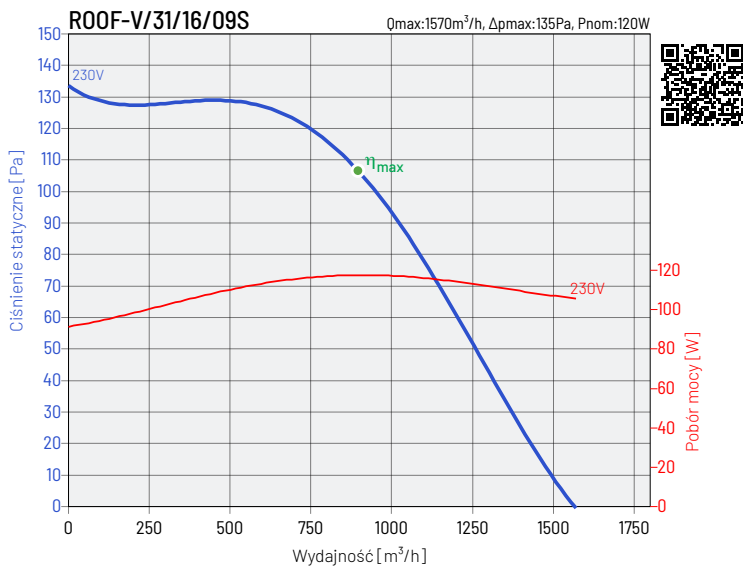
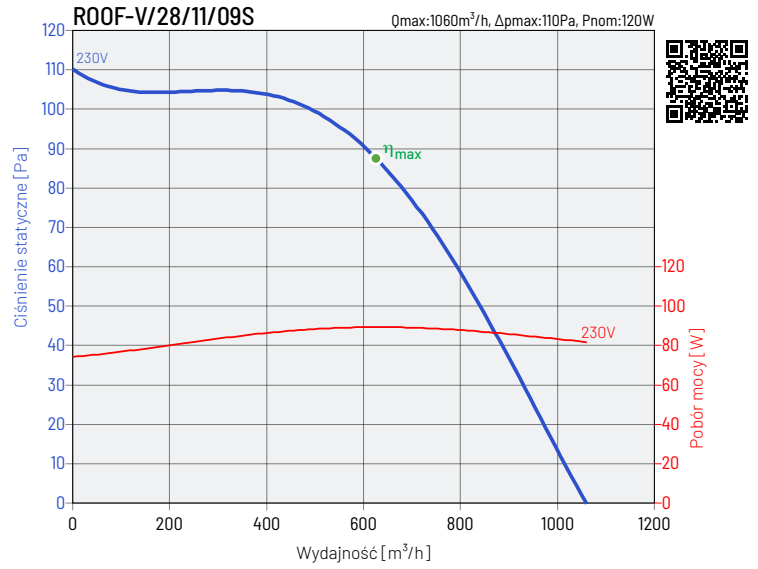
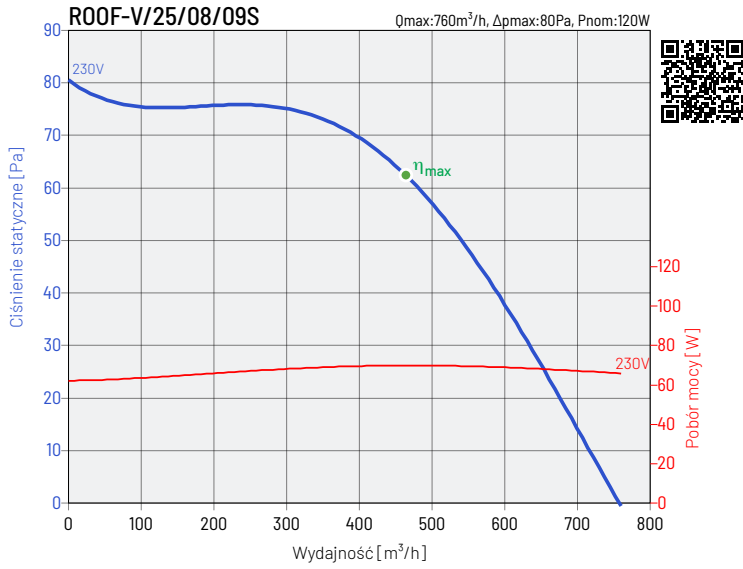



## CHARAKTERYSTYKI PRACY WENTYLATORÓW

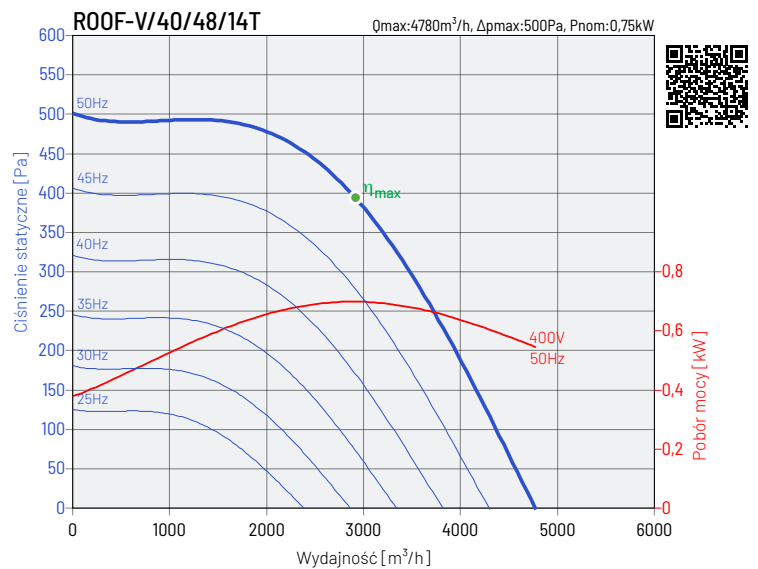
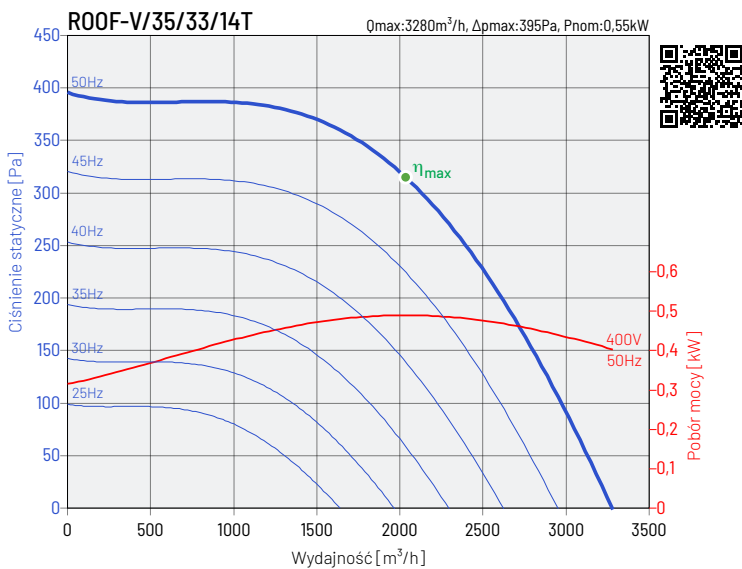
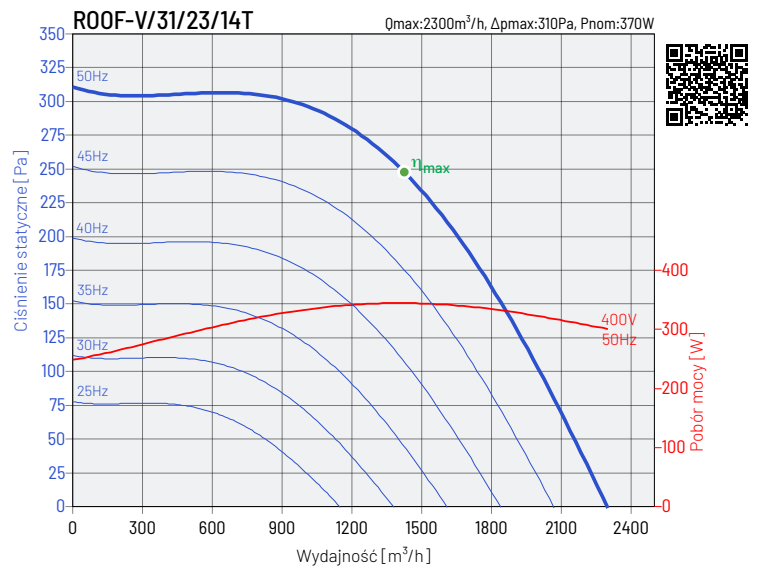
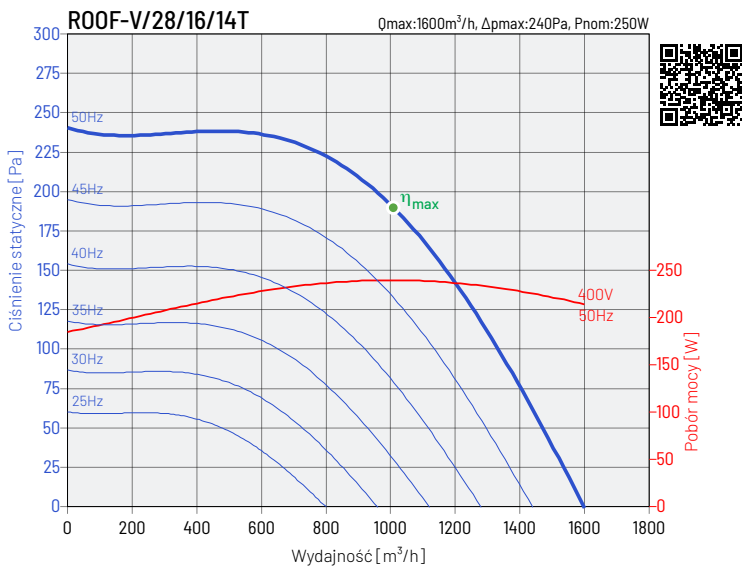
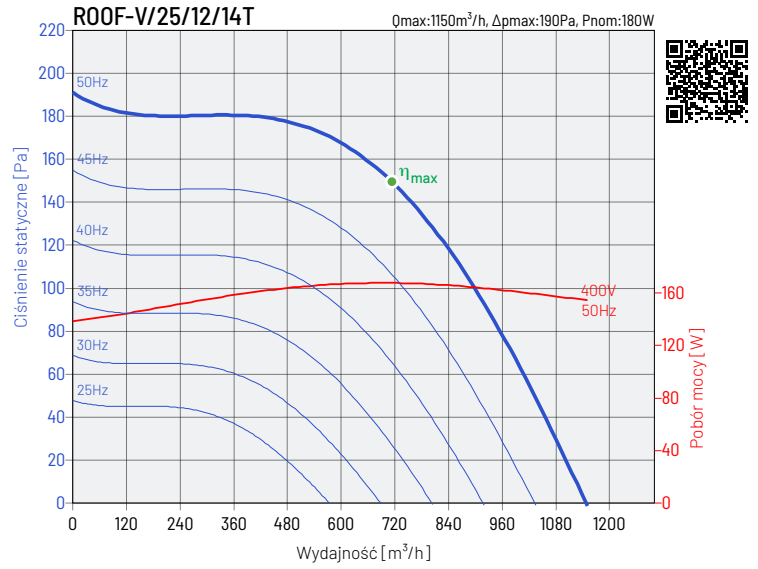
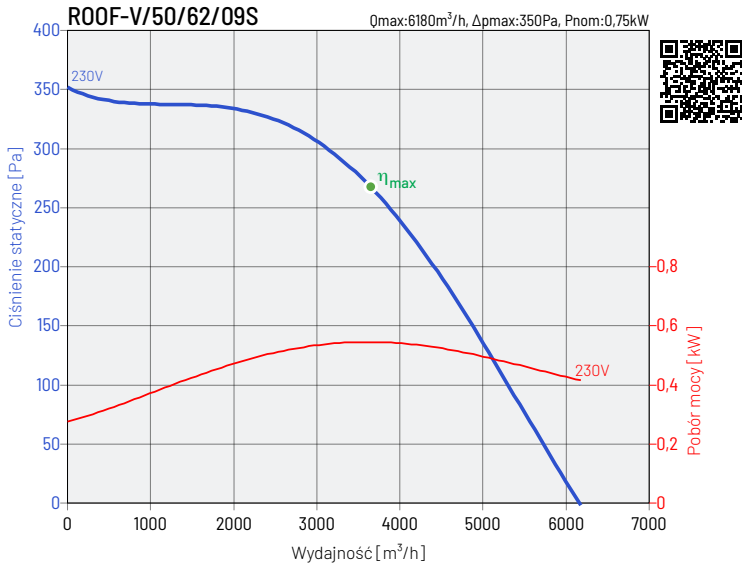



## CHARAKTERYSTYKI PRACY WENTYLATORÓW

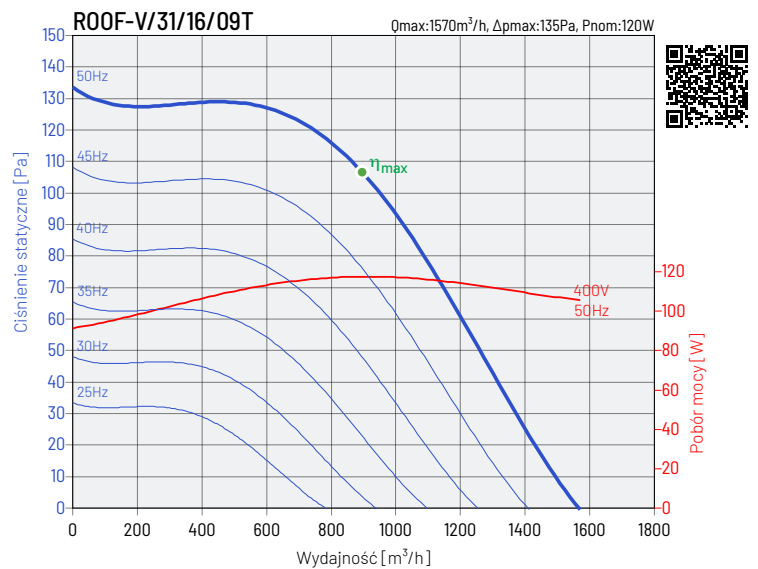
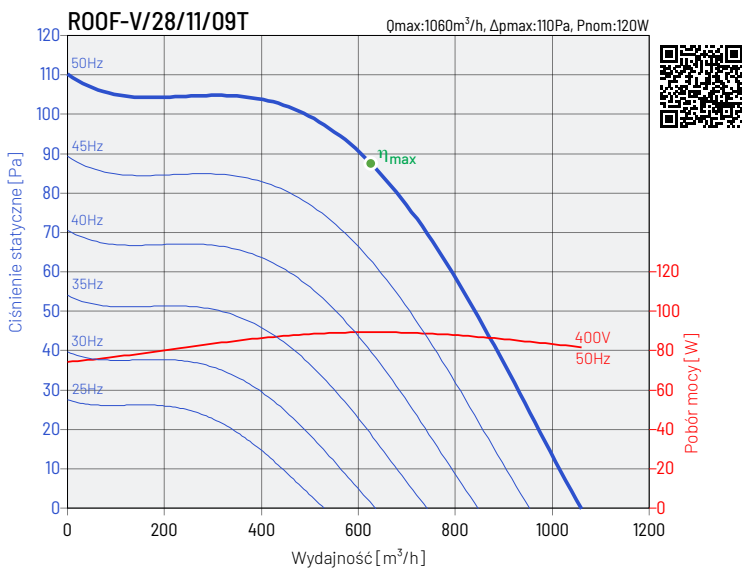
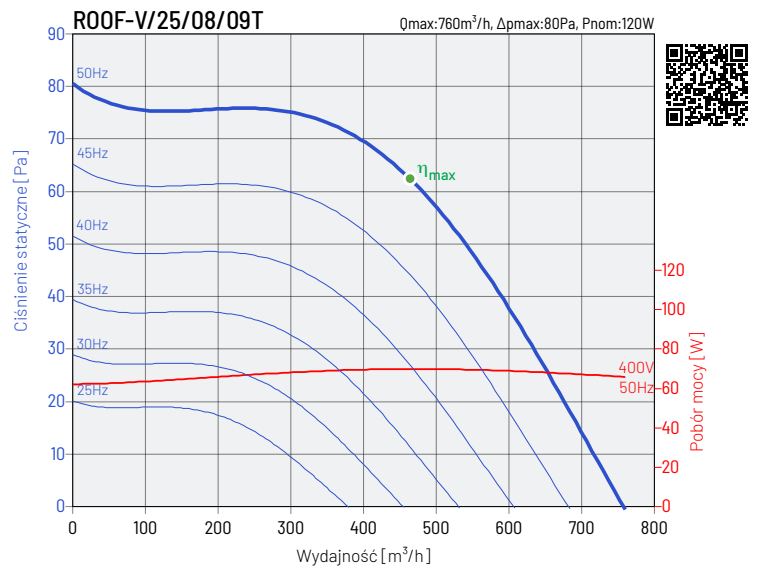
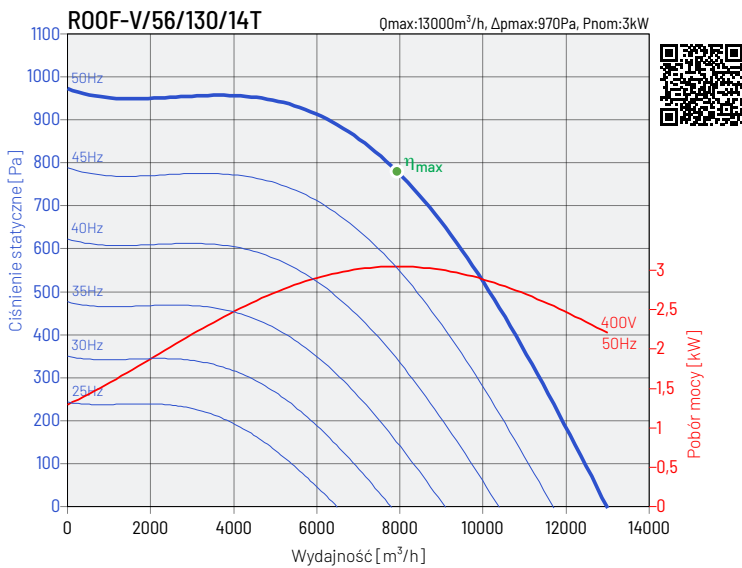
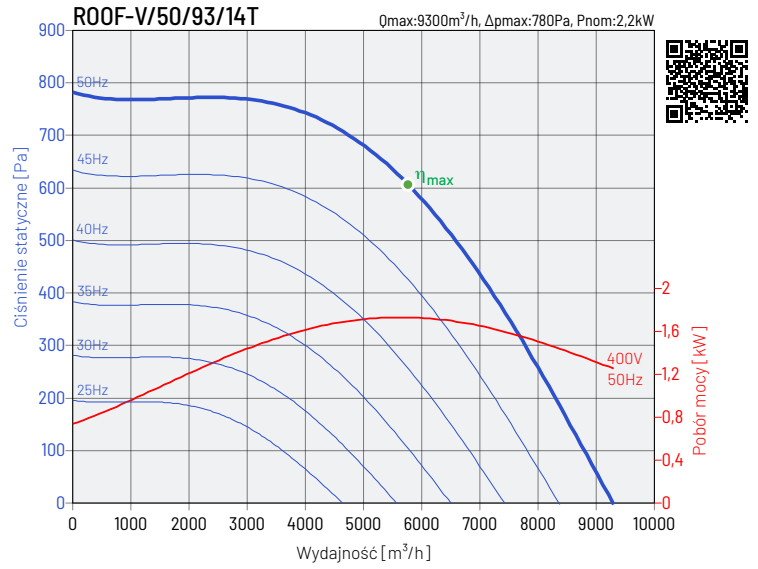
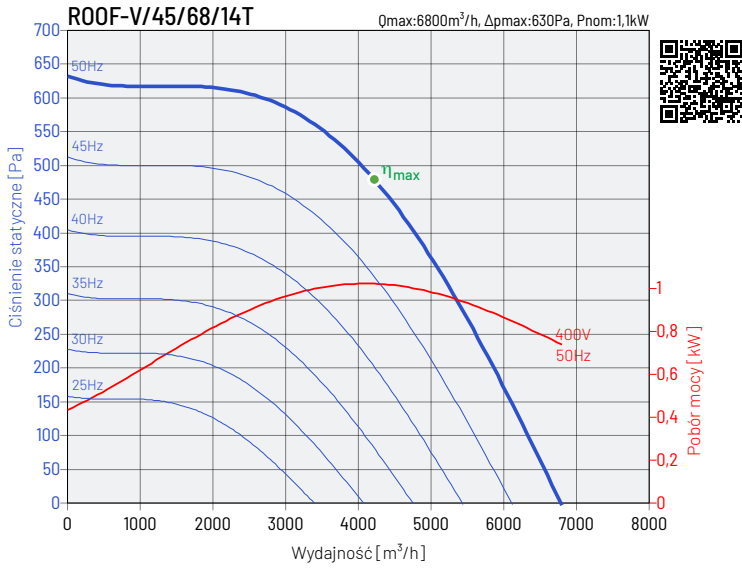



## CHARAKTERYSTYKI PRACY WENTYLATORÓW

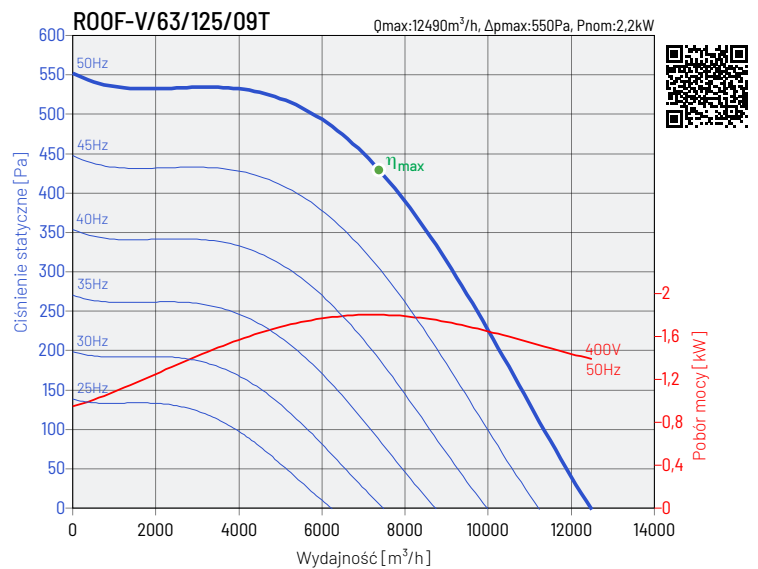
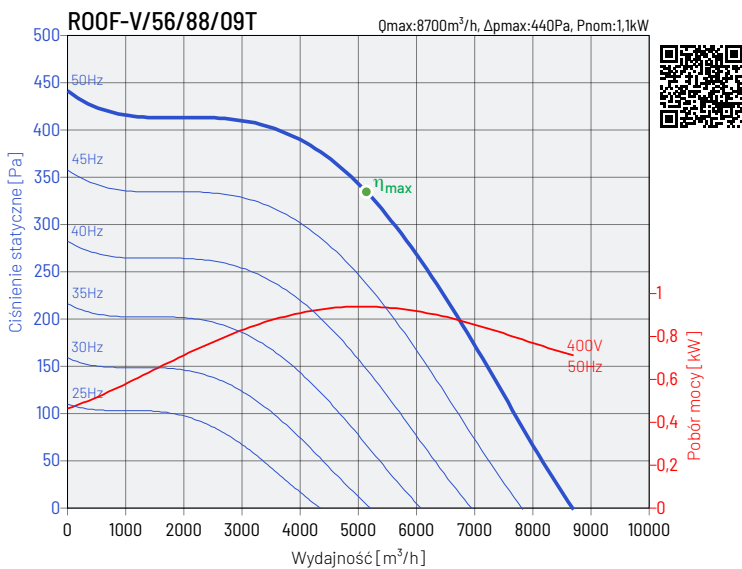
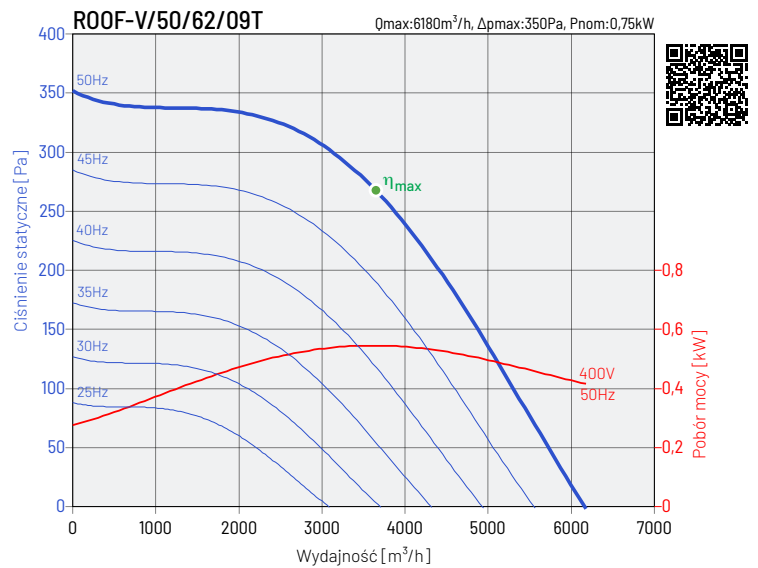
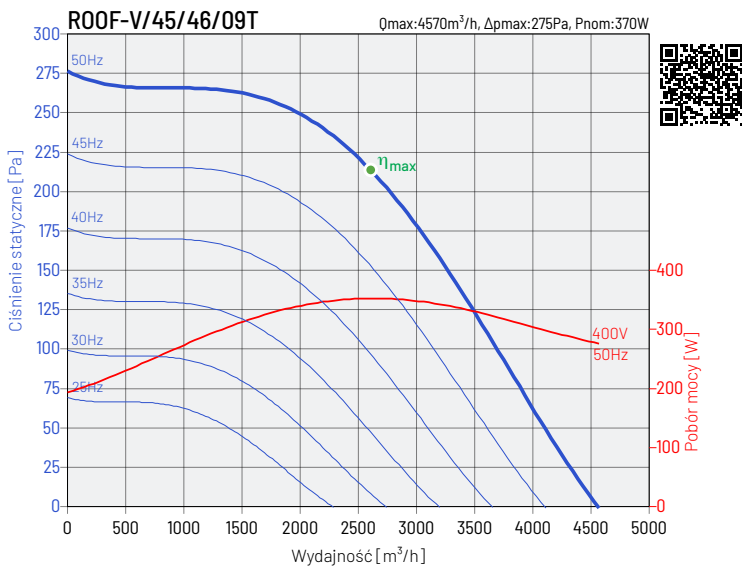
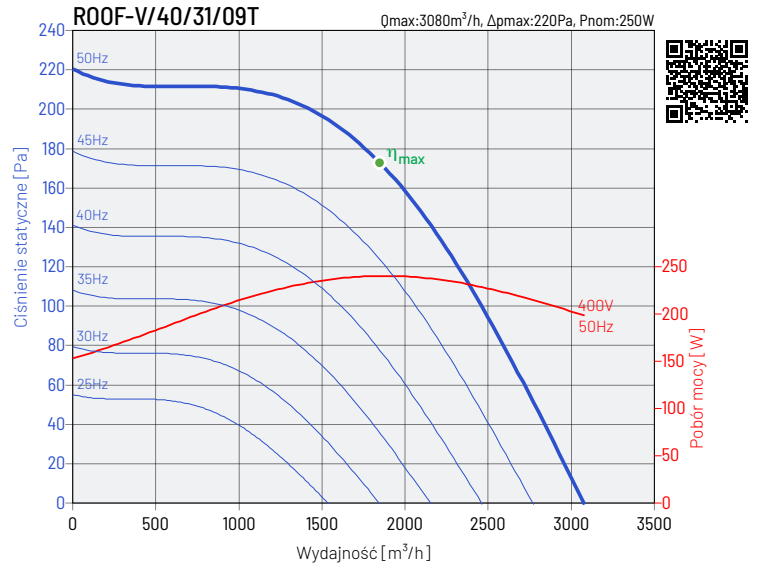
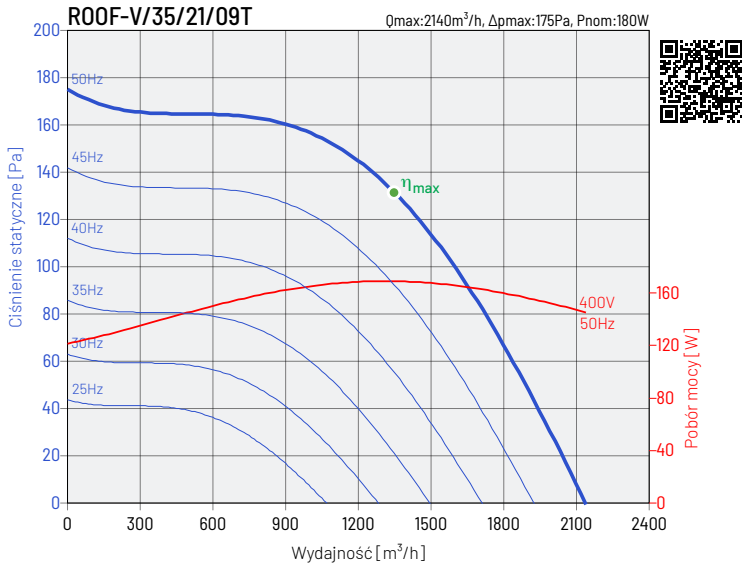



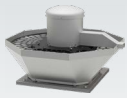

## CHARAKTERYSTYKI PRACY WENTYLATORÓW

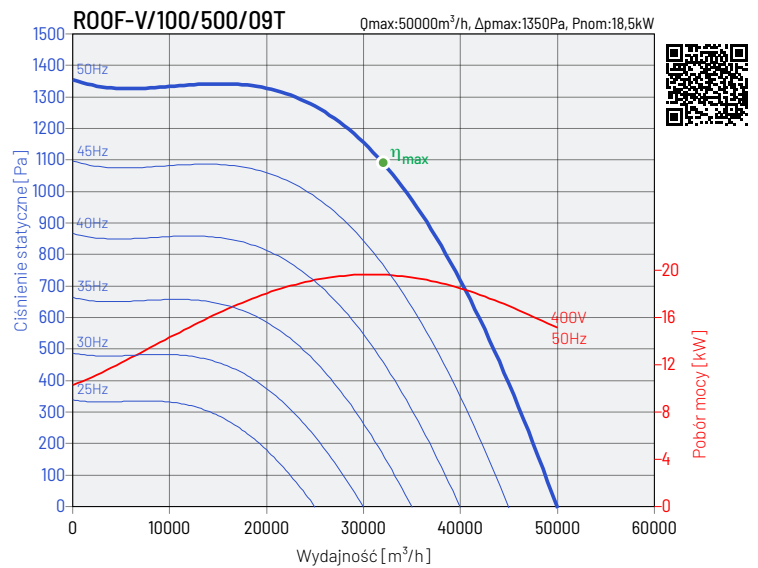
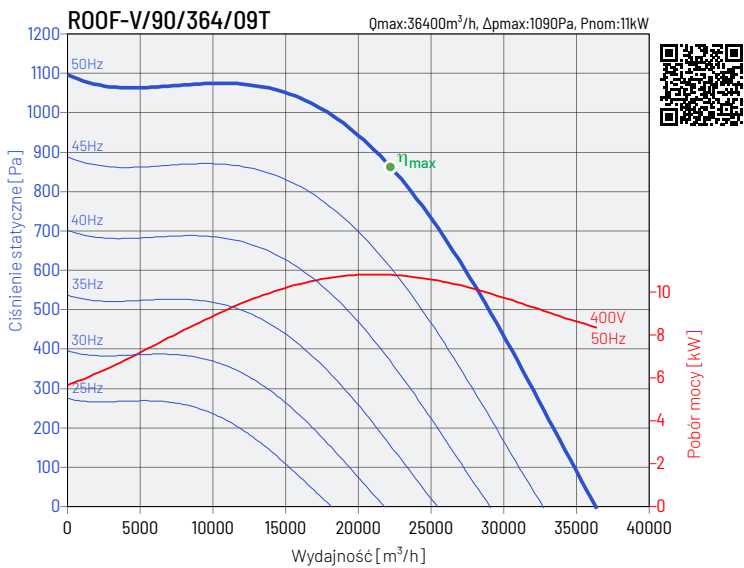
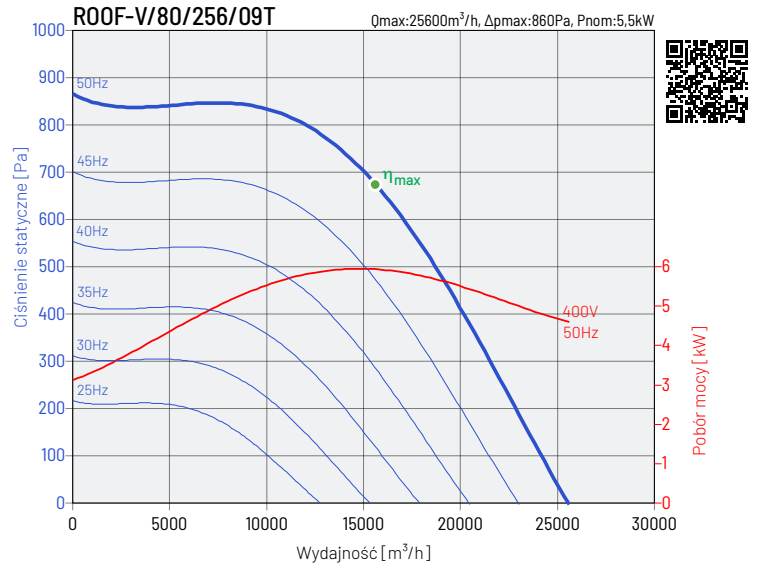
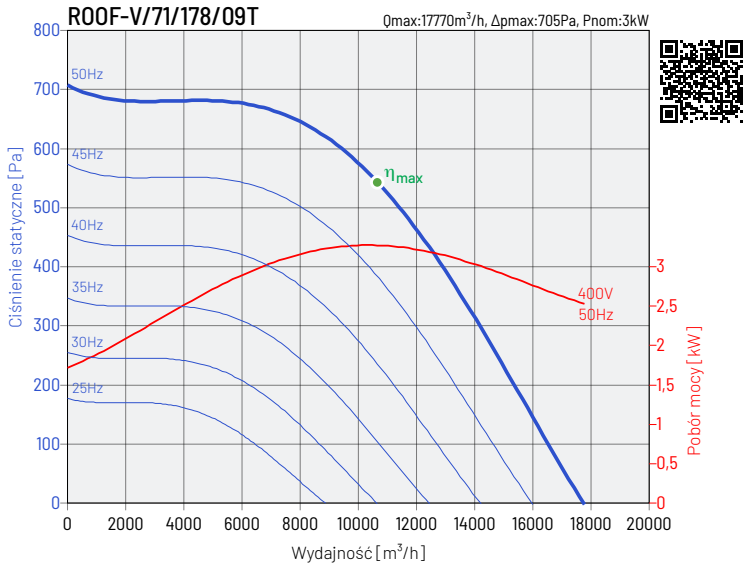

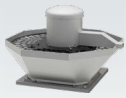

# ROOF-V Wentylator dachowy

The power of AIR



## WYMIARY

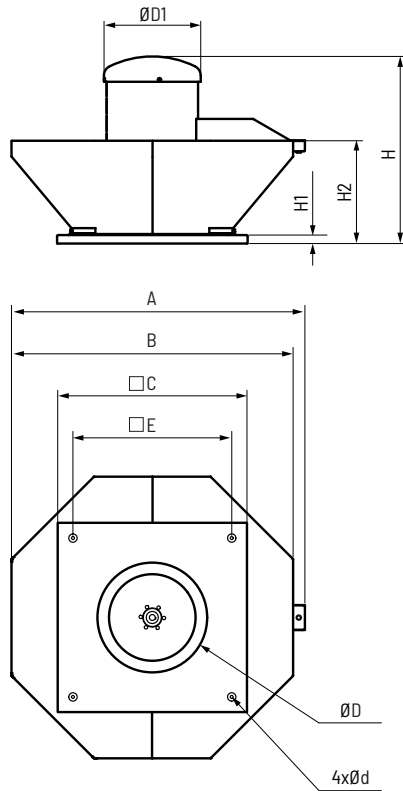

model wentylatora	A mm	B mm	C mm	$\varnothing d$ mm	$\varnothing D$ mm	$\varnothing D1$ mm	E mm	H mm	H1 mm	H2 mm
ROOF-V/25	589	535	435	12	200	318	330	442	15	246
ROOF-V/28	589	535	435	12	225	318	330	442	15	246
ROOF-V/31	723	668	435	12	250	318	330	477	15	261
ROOF-V/35	811	755	560	12	280	355	450	569	15	298
ROOF-V/40	904	848	560	12	315	355	450	586	15	298
ROOF-V/45	936	880	630	12	355	457	535	631	15	356
ROOF-V/50	1104	1048	710	12	400	457	590	801	17	393
ROOF-V/56	1234	1178	710	12	450	457	590	841	17	433
ROOF-V/63	1386	1330	900	14	500	457	750	884	40	484
ROOF-V/71	1556	1500	900	14	560	550	750	1044	40	543
ROOF-V/80	1736	1680	1100	14	630	550	840	1104	40	585
ROOF-V/90	1926	1870	1250	14	710	765	1000	1195	40	640
ROOF-V/100	2148	2094	1250	14	800	765	1000	1417	40	725

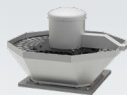

# ROOF-V Wentylator dachowy



## AKCESORIA MONTAŻOWE

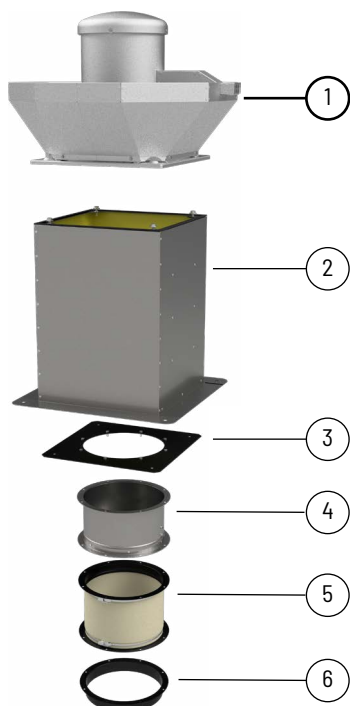

wentylator	podstawa dachowa krótka RSS	podstawa dachowa RS	podstawa dachowa RS-I	podstawa dachowa RSA	podstawa dachowa RSA-I
ROOF-V/25	RSS 435	RS 435	RS-I 435	RSA 435	RSA-I 435
ROOF-V/28	RSS 435	RS 435	RS-I 435	RSA 435	RSA-I 435
ROOF-V/31	RSS 435	RS 435	RS-I 435	RSA 435	RSA-I 435
ROOF-V/35	RSS 560	RS 560	RS-I 560	RSA 560	RSA-I 560
ROOF-V/40	RSS 560	RS 560	RS-I 560	RSA 560	RSA-I 560
ROOF-V/45	RSS 630	RS 630	RS-I 630	RSA 630	RSA-I 630
ROOF-V/50	RSS 710	RS 710	RS-I 710	RSA 710	RSA-I 710
ROOF-V/56	RSS 710	RS 710	RS-I 710	RSA 710	RSA-I 710
ROOF-V/63	RSS 905	RS 905	RS-I 905	RSA 905	RSA-I 905
ROOF-V/71	RSS 905	RS 905	RS-I 905	RSA 905	RSA-I 905
ROOF-V/80	RSS 1100	RS 1100	RS-I 1100	RSA 1100	RSA-I 1100
ROOF-V/90	-	RS 1250	RS-I 1250	RSA 1250	RSA-I 1250
ROOF-V/100	-	RS 1250	RS-I 1250	RSA 1250	RSA-I 1250

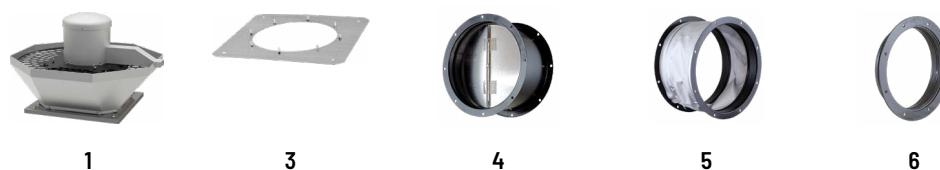

wentylator	złącze P	kłapa zwrotna KZD SE	złącze przeciw drganiowe ZDPO	króciec K
ROOF-V/25	P 435	KZD SE 435	ZDPO 435	K 435
ROOF-V/28	P 435	KZD SE 435	ZDPO 435	K 435
ROOF-V/31	P 435	KZD SE 435	ZDPO 435	K 435
ROOF-V/35	P 560	KZD SE 560	ZDPO 560	K 560
ROOF-V/40	P 560	KZD SE 560	ZDPO 560	K 560
ROOF-V/45	P 630	KZD SE 630	ZDPO 630	K 630
ROOF-V/50	P 710	KZD SE 710	ZDPO 710	K 710
ROOF-V/56	P 710	KZD SE 710	ZDPO 710	K 710
ROOF-V/63	P 905	KZD SE 905	ZDPO 905	K 905
ROOF-V/71	P 905	KZD SE 905	ZDPO 905	K 905
ROOF-V/80	P 1100	KZD SE 1100	ZDPO 1100	K 1100
ROOF-V/90	P 1250	KZD SE 1250	ZDPO 1250	K 1250
ROOF-V/100	P 1250	KZD SE 1250	ZDPO 1250	K 1250

## Numery artykułów

43526520 RSS 435	43526020 RS 435	43526120 RSA 435	43526310 P 435	43527410 ZDPO 435	43526410 K 435
43526530 RSS 560	43526030 RS 560	43526130 RSA 560	43526320 P 560	43527420 ZDPO 560	43526420 K 560
43526540 RSS 630	43526040 RS 630	43526140 RSA 630	43526330 P 630	43527430 ZDPO 630	43526430 K 630
43526550 RSS 710	43526050 RS 710	43526150 RSA 710	43526340 P 710	43527440 ZDPO 710	43526440 K 710
43526560 RSS 905	43526060 RS 905	43526160 RSA 905	43526350 P 905	43527450 ZDPO 905	43526450 K 905
43526570 RSS 1100	43526070 RS 1100	43526170 RSA 1100	43526360 P 1100	43527460 ZDPO 1100	43526460 K 1100
43526580 RSS 1250	43526080 RS 1250	43526180 RSA 1250	43526370 P 1250	43527470 ZDPO 1250	43526470 K 1250
	43526721 RS-I 435	43526821 RSA-I 435	43527312 KZD SE 435		
	43526731 RS-I 560	43526831 RSA-I 560	43527322 KZD SE 560		
	43526741 RS-I 630	43526841 RSA-I 630	43527332 KZD SE 630		
	43526751 RS-I 710	43526851 RSA-I 710	43527342 KZD SE 710		
	43526761 RS-I 905	43526861 RSA-I 905	43527352 KZD SE 905		
	43526771 RS-I 1100	43526871 RSA-I 1100	43527362 KZD SE 1100		
	43526781 RS-I 1250	43526881 RSA-I 1250	43527372 KZD SE 1250		

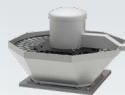

## AKCESORIA ELEKTRYCZNE



wentylator	termostat ścienny	termostat kanałowy	czujnik temperatury	czujnik zanieczyszczenia	higrostat	regulator tyrystorowy
	TS*	TK-21	do TK-21	SQA	HIG-2	REB
ROOF-V/25/12/14S	TS	TK-21	Czujnik TK-21	SQA	HIG-2	REB-5
ROOF-V/28/16/14S	TS	TK-21	Czujnik TK-21	SQA + DILM7-10	HIG-2 + DILM7-10	REB-5
ROOF-V/31/23/14S	TS + DILM7-10	TK-21	Czujnik TK-21	SQA + DILM7-10	HIG-2 + DILM7-10	REB-5
ROOF-V/35/33/14S	TS + DILM7-10	TK-21 + DILM7-10	Czujnik TK-21	SQA + DILM7-10	HIG-2 + DILM7-10	REB-10
ROOF-V/40/48/14S	TS + DILM7-10	TK-21 + DILM7-10	Czujnik TK-21	SQA + DILM7-10	HIG-2 + DILM7-10	REB-10
ROOF-V/45/68/14S	TS + DILM7-10	TK-21 + DILM7-10	Czujnik TK-21	SQA + DILM7-10	HIG-2 + DILM7-10	REB-10
ROOF-V/25/08/09S	TS	TK-21	Czujnik TK-21	SQA	HIG-2	REB-5
ROOF-V/28/11/09S	TS	TK-21	Czujnik TK-21	SQA	HIG-2	REB-5
ROOF-V/31/16/09S	TS	TK-21	Czujnik TK-21	SQA	HIG-2	REB-5
ROOF-V/35/21/09S	TS	TK-21	Czujnik TK-21	SQA	HIG-2	REB-5
ROOF-V/40/31/09S	TS	TK-21	Czujnik TK-21	SQA + DILM7-10	HIG-2 + DILM7-10	REB-5
ROOF-V/45/46/09S	TS + DILM7-10	TK-21	Czujnik TK-21	SQA + DILM7-10	HIG-2 + DILM7-10	REB-10
ROOF-V/50/62/09S	TS + DILM7-10	TK-21 + DILM7-10	Czujnik TK-21	SQA + DILM7-10	HIG-2 + DILM7-10	REB-10
ROOF-V/25/12/14T	TS + DILM7-10	TK-21 + DILM7-10	Czujnik TK-21	SQA + DILM7-10	HIG-2 + DILM7-10	-
ROOF-V/28/16/14T	TS + DILM7-10	TK-21 + DILM7-10	Czujnik TK-21	SQA + DILM7-10	HIG-2 + DILM7-10	-
ROOF-V/31/23/14T	TS + DILM7-10	TK-21 + DILM7-10	Czujnik TK-21	SQA + DILM7-10	HIG-2 + DILM7-10	-
ROOF-V/35/33/14T	TS + DILM7-10	TK-21 + DILM7-10	Czujnik TK-21	SQA + DILM7-10	HIG-2 + DILM7-10	-
ROOF-V/40/48/14T	TS + DILM7-10	TK-21 + DILM7-10	Czujnik TK-21	SQA + DILM7-10	HIG-2 + DILM7-10	-
ROOF-V/45/68/14T	TS + DILM7-10	TK-21 + DILM7-10	Czujnik TK-21	SQA + DILM7-10	HIG-2 + DILM7-10	-
ROOF-V/50/93/14T	TS + DILM7-10	TK-21 + DILM7-10	Czujnik TK-21	SQA + DILM7-10	HIG-2 + DILM7-10	-
ROOF-V/56/130/14T	TS + DILM7-10	TK-21 + DILM7-10	Czujnik TK-21	SQA + DILM7-10	HIG-2 + DILM7-10	-
ROOF-V/25/08/09T	TS + DILM7-10	TK-21 + DILM7-10	Czujnik TK-21	SQA + DILM7-10	HIG-2 + DILM7-10	-
ROOF-V/28/11/09T	TS + DILM7-10	TK-21 + DILM7-10	Czujnik TK-21	SQA + DILM7-10	HIG-2 + DILM7-10	-
ROOF-V/31/16/09T	TS + DILM7-10	TK-21 + DILM7-10	Czujnik TK-21	SQA + DILM7-10	HIG-2 + DILM7-10	-
ROOF-V/35/21/09T	TS + DILM7-10	TK-21 + DILM7-10	Czujnik TK-21	SQA + DILM7-10	HIG-2 + DILM7-10	-
ROOF-V/40/31/09T	TS + DILM7-10	TK-21 + DILM7-10	Czujnik TK-21	SQA + DILM7-10	HIG-2 + DILM7-10	-
ROOF-V/45/46/09T	TS + DILM7-10	TK-21 + DILM7-10	Czujnik TK-21	SQA + DILM7-10	HIG-2 + DILM7-10	-
ROOF-V/50/62/09T	TS + DILM7-10	TK-21 + DILM7-10	Czujnik TK-21	SQA + DILM7-10	HIG-2 + DILM7-10	-
ROOF-V/56/88/09T	TS + DILM7-10	TK-21 + DILM7-10	Czujnik TK-21	SQA + DILM7-10	HIG-2 + DILM7-10	-
ROOF-V/63/125/09T	TS + DILM7-10	TK-21 + DILM7-10	Czujnik TK-21	SQA + DILM7-10	HIG-2 + DILM7-10	-
ROOF-V/71/178/09T	TS + DILM7-10	TK-21 + DILM7-10	Czujnik TK-21	SQA + DILM7-10	HIG-2 + DILM7-10	-
ROOF-V/80/256/09T	TS + DILM15-10	TK-21 + DILM15-10	Czujnik TK-21	SQA + DILM15-10	HIG-2 + DILM15-10	-
ROOF-V/90/364/09T	TS + DILM25-10	TK-21 + DILM25-10	Czujnik TK-21	SQA + DILM25-10	HIG-2 + DILM25-10	-
ROOF-V/100/500/09T	TS + DILM40-10	TK-21 + DILM40-10	Czujnik TK-21	SQA + DILM40-10	HIG-2 + DILM40-10	-

\* silnik jednofazowe wykorzystać wszystkie tory w styczniku

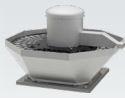

# ROOF-V Wentylator dachowy

## AKCESORIA ELEKTRYCZNE



wentylator	11-stopniowy regulator tyrystorowy	regulator transformatorowy			regulator transformatorowy 2-nastawowy	falownik
	IRF	RMB	RVS	SC2A	L	
ROOF-V/25/12/14S	IRF-900	RMB 3,5	RVS 3	SC2A1-25L25	-	
ROOF-V/28/16/14S	IRF-900	RMB 3,5	RVS 3	SC2A1-25L25	-	
ROOF-V/31/23/14S	IRF-900	RMB 3,5	RVS 5	SC2A1-35L25	-	
ROOF-V/35/33/14S	IRF-900	RMB 8	RVS 5	SC2A1-50L25	-	
ROOF-V/40/48/14S	IRF-900	RMB 8	RVS 5	SC2A1-50L25	-	
ROOF-V/45/68/14S	-	RMB 10	RVS 10	SC2A1-110L25	-	
ROOF-V/25/08/09S	IRF-900	RMB 3,5	RVS 3	SC2A1-25L25	-	
ROOF-V/28/11/09S	IRF-900	RMB 3,5	RVS 3	SC2A1-25L25	-	
ROOF-V/31/16/09S	IRF-900	RMB 3,5	RVS 3	SC2A1-25L25	-	
ROOF-V/35/21/09S	IRF-900	RMB 3,5	RVS 3	SC2A1-25L25	-	
ROOF-V/40/31/09S	IRF-900	RMB 3,5	RVS 3	SC2A1-25L25	-	
ROOF-V/45/46/09S	IRF-900	RMB 3,5	RVS 5	SC2A1-50L25	-	
ROOF-V/50/62/09S	IRF-900	RMB 8	RVS 7	SC2A1-75L25	-	
ROOF-V/25/12/14T	-	-	-	SC2A4-15L55	L 0,4kW	
ROOF-V/28/16/14T	-	-	-	SC2A4-15L55	L 0,4kW	
ROOF-V/31/23/14T	-	-	-	SC2A4-15L55	L 0,4kW	
ROOF-V/35/33/14T	-	-	-	SC2A4-25L55	L 0,75kW	
ROOF-V/40/48/14T	-	-	-	SC2A4-25L55	L 0,75kW	
ROOF-V/45/68/14T	-	-	-	SC2A4-40L55	L 1,5kW	
ROOF-V/50/93/14T	-	-	-	SC2A4-60L55	L 2,2kW	
ROOF-V/56/130/14T	-	-	-	SC2A4-80L55	L 4,0kW	
ROOF-V/25/08/09T	-	-	-	SC2A4-15L55	L 0,4kW	
ROOF-V/28/11/09T	-	-	-	SC2A4-15L55	L 0,4kW	
ROOF-V/31/16/09T	-	-	-	SC2A4-15L55	L 0,4kW	
ROOF-V/35/21/09T	-	-	-	SC2A4-15L55	L 0,4kW	
ROOF-V/40/31/09T	-	-	-	SC2A4-15L55	L 0,4kW	
ROOF-V/45/46/09T	-	-	-	SC2A4-15L55	L 0,4kW	
ROOF-V/50/62/09T	-	-	-	SC2A4-25L55	L 0,75kW	
ROOF-V/56/88/09T	-	-	-	SC2A4-40L55	L 1,5kW	
ROOF-V/63/125/09T	-	-	-	SC2A4-40L55	L 2,2kW	
ROOF-V/71/178/09T	-	-	-	SC2A4-80L55	L 4,0kW	
ROOF-V/80/256/09T	-	-	-	-	L 5,5kW	
ROOF-V/90/364/09T	-	-	-	-	L 11,0kW	
ROOF-V/100/500/09T	-	-	-	-	L 18,5kW	

### Numery artykułów

91040997 DILM7-10	40025345 TS	40025051 REB-5	40025234 RVS 3	40025253 SC2A1-25L25	40016302 L 0,4kW
91040666-42 DILM15-10	40025320 TK-21	40025055 REB-10	40025235 RVS 5	40025255 SC2A1-35L25	40016312 L 0,75kW
91040905 DILM25-10	40025140 SQA	40015154 IRF-900	40025236 RVS 7	40025257 SC2A1-50L25	40016322 L 1,5kW
91040666 DILM40-10	40025150 HIG-2	40025070 RMB 3,5	40025237 RVS 10	40025259 SC2A1-75L25	40016332 L 2,2kW
		40025080 RMB 8		40025251 SC2A1-110L25	40016352 L 4,0kW
		40025090 RMB 10		40025270 SC2A4-15L55	40016362 L 5,5kW
				40025272 SC2A4-25L55	40016383 L 11,0kW
				40025274 SC2A4-40L55	40016412 L 18,5kW
				40025276 SC2A4-60L55	
				40025278 SC2A4-80L55	